

# M63824GP/KP

7-UNIT 500mA DARLINGTON TRANSISTOR-ARRAY WITH CLAMP DIODE

## DESCRIPTION

The M63824GP/KP 7-channel sinkdriver, consists of 14 NPN transistors connected to form seven high current gain driver pairs.

## FEATURES

- High breakdown voltage ( $BV_{CEO} \geq 50V$ )
- High-current driving ( $I_{C(max)} = 500mA$ )
- With clamping diodes
- 3V micro computer series compatible input
- Wide operating temperature range ( $T_a = -40$  to  $+85^\circ C$ )

## APPLICATION

Output for 3 voltage microcomputer series and interface with high voltage system. Relay and small printer driver, LED, or incandescent display digit driver.

## FUNCTION

The M63824GP/KP is transistor-array of high active level seven units type which can do direct drive of 3 voltage micro-computer series. A resistor of  $1.05k\Omega$  is connected between the input pin. A clamp diode for inductive load transient suppression is connected for the output pin (collector) and COM pin (pin9). All emitters of the output transistor are connected to GND (pin8). The outputs are capable of driving 500mA and are rated for operation with output voltage up to 50V.

## PIN CONFIGURATION

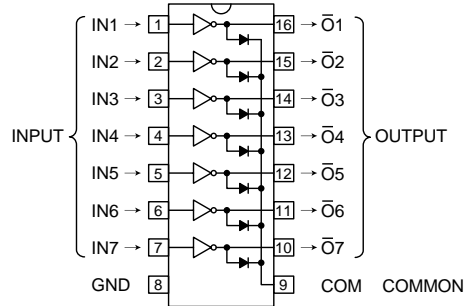

16P2S-A(GP)  
Package type 16P2Z-A(KP)

## CIRCUIT DIAGRAM

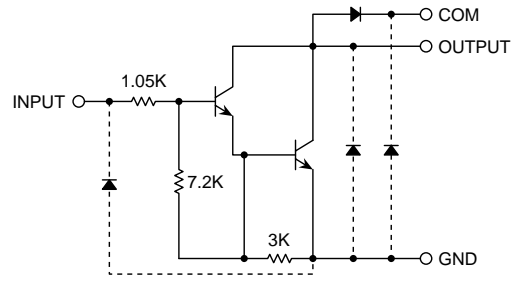

The seven circuits share the COM and GND

The diode, indicated with the dotted line, is parasitic, and cannot be used.

Unit :  $\Omega$

## ABSOLUTE MAXIMUM RATINGS (Unless otherwise noted, $T_a = -40 \sim +85^\circ C$ )

Symbol	Parameter	Conditions	Ratings	Unit
$V_{CEO}$	Collector-emitter voltage	Output, H	$-0.5 \sim +50$	V
$I_C$	Collector current	Current per circuit output, L	500	mA
$V_i$	Input voltage		$-0.5 \sim +10$	V
$I_F$	Clamping diode forward current		500	mA
$V_R$	Clamping diode reverse voltage		50	V
$P_d$	Power dissipation	$T_a = 25^\circ C$ , when mounted on board	0.80(GP)/0.6(KP)	W
$T_{opr}$	Operating temperature		$-40 \sim +85$	$^\circ C$
$T_{stg}$	Storage temperature		$-55 \sim +125$	$^\circ C$

# M63824GP/KP

## 7-UNIT 500mA DARLINGTON TRANSISTOR-ARRAY WITH CLAMP DIODE

### RECOMMENDED OPERATING CONDITIONS (Unless otherwise noted, Ta = -40 ~ +85°C)

Symbol	Parameter	Conditions	Limits			Unit
			min	typ	max	
Vo	Output voltage		0	—	50	V
Ic	Collector current (Current per 1 circuit when 7 circuits are coming on simultaneously)	Duty Cycle GP : no more than 4% KP : no more than 3%	0	—	400	mA
		Duty Cycle GP : no more than 15% KP : no more than 12%	0	—	200	
VIH	"H" input voltage	Ic ≤ 400mA	2.4	—	10	V
VIL	"L" input voltage		0	—	0.4	V

### ELECTRICAL CHARACTERISTICS (Unless otherwise noted, Ta = 25°C)

Symbol	Parameter	Test conditions	Limits			Unit
			min	typ	max	
V (BR) CEO	Collector-emitter breakdown voltage	ICEO = 100μA	50	—	—	V
VCE(sat)	Collector-emitter saturation voltage	II = 500μA, IC = 350mA	—	1.2	1.6	V
		II = 350μA, IC = 200mA	—	1.0	1.3	
		II = 250μA, IC = 100mA	—	0.9	1.1	
II	Input current	VI = 3V	—	1.5	2.4	mA
VF	Clamping diode forward voltage	IF = 350mA	—	1.4	2.0	V
IR	Clamping diode reverse current	VR = 50V	—	—	100	μA
hFE	DC amplification factor	VCE = 2V, IC = 350mA	1000	2500	—	—

### SWITCHING CHARACTERISTICS (Unless otherwise noted, Ta = 25°C)

Symbol	Parameter	Test conditions	Limits			Unit
			min	typ	max	
ton	Turn-on time	CL = 15pF (note 1)	—	15	—	ns
toff	Turn-off time		—	350	—	ns

### NOTE 1 TEST CIRCUIT

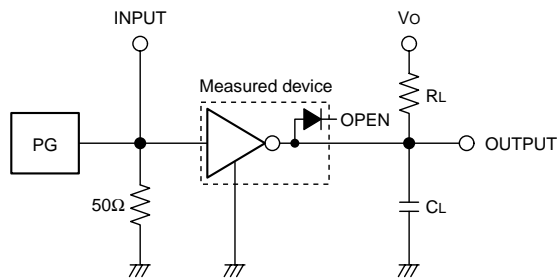

- (1) Pulse generator (PG) characteristics : PRR=1kHz,  
tw = 10μs, tr = 6ns, tf = 6ns, Zo = 50Ω  
VI = 0 ~ 3V
- (2) Input-output conditions : RL = 25Ω, Vo = 10V
- (3) Electrostatic capacity CL includes floating capacitance  
at connections and input capacitance at probes

### TIMING DIAGRAM

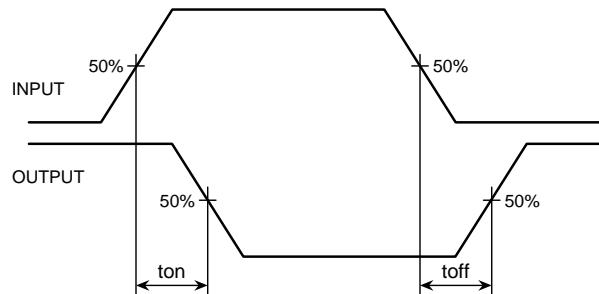

# M63824GP/KP

## 7-UNIT 500mA DARLINGTON TRANSISTOR-ARRAY WITH CLAMP DIODE

### TYPICAL CHARACTERISTICS

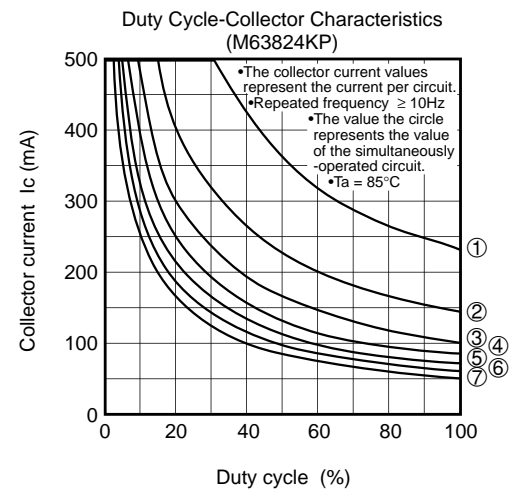
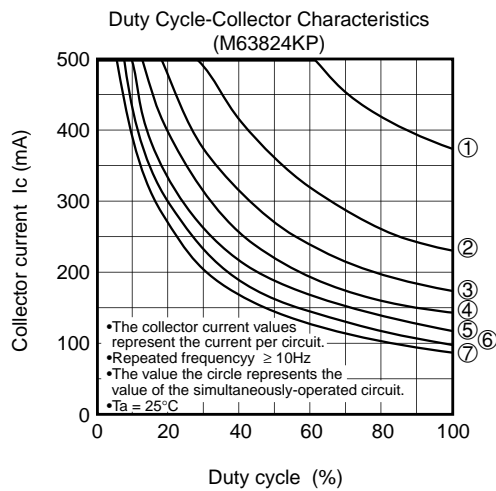
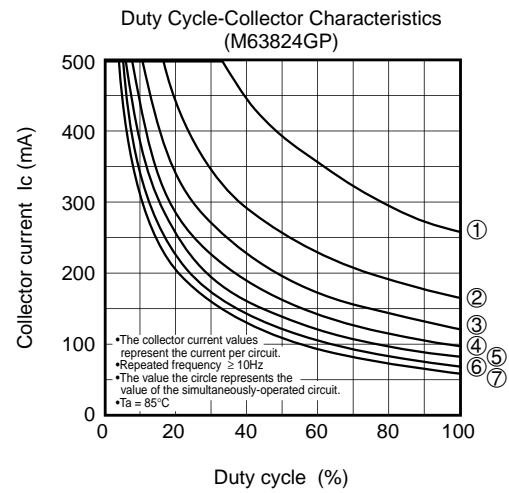
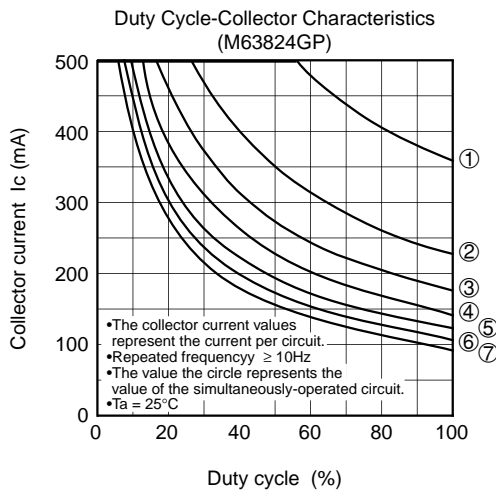
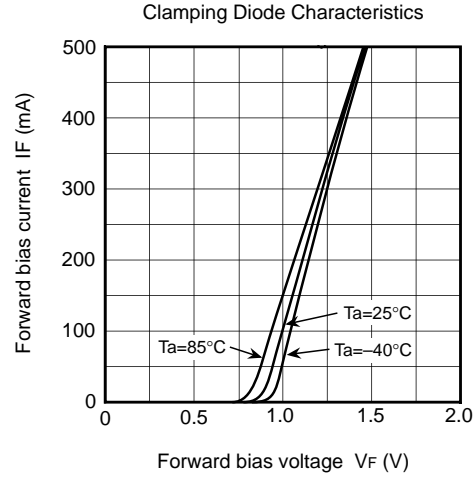
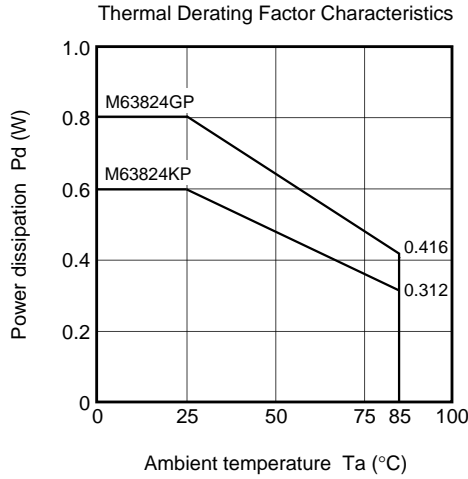

**M63824GP/KP**

7-UNIT 500mA DARLINGTON TRANSISTOR-ARRAY WITH CLAMP DIODE

