

PRELIMINARY
 Notice: This is not a final specification.
 Some parametric limits are subject to change.

MITSUBISHI SEMICONDUCTOR <TRANSISTOR ARRAY>

M63813P/FP/GP/KP

7-UNIT 300mA TRANSISTOR ARRAY WITH CLAMP DIODE

DESCRIPTION

M63813P/FP/GP/KP are seven-circuit Single transistor arrays with clamping diodes. The circuits are made of NPN transistors. Both the semiconductor integrated circuits perform high-current driving with extremely low input-current supply.

FEATURES

- Four package configurations (P, FP, GP and KP)
- Medium breakdown voltage ($BV_{CEO} \geq 35V$)
- Synchronizing current ($I_{C(max)} = 300mA$)
- With clamping diodes
- Low output saturation voltage
- Wide operating temperature range ($T_a = -40$ to $+85^\circ C$)

APPLICATION

Driving of digit drives of indication elements (LEDs and lamps) with small signals

FUNCTION

The M63813P/FP/GP/KP each have seven circuits consisting of NPN transistor. A spike-killer clamping diode is provided between each output pin (collector) and COM pin (pin9). The transistor emitters are all connected to the GND pin (pin 8). The transistors allow synchronous flow of 300mA collector current. A maximum of 35V voltage can be applied between the collector and emitter.

PIN CONFIGURATION

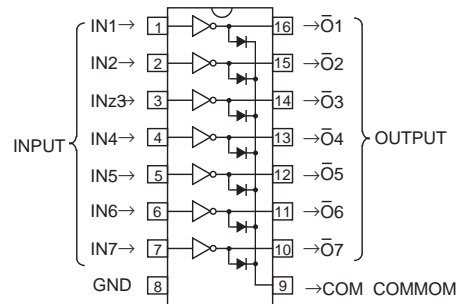

Package type
 16P4(P)
 16P2N-A(FP)
 16P2S-A(GP)
 16P2Z-A(KP)

CIRCUIT DIAGRAM

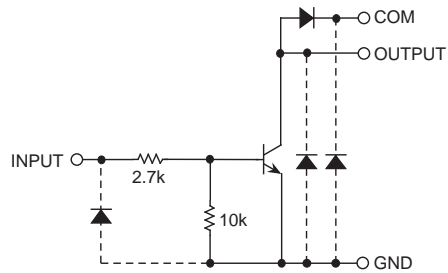

The seven circuits share the COM and GND.
 The diode, indicated with the dotted line, is parasitic, and cannot be used.

Unit: Ω

ABSOLUTE MAXIMUM RATINGS (Unless otherwise noted, $T_a = -40 \sim +85^\circ C$)

| Symbol | Parameter | Conditions | Ratings | Unit | |
|-----------|--------------------------------|--|------------|------------|---|
| V_{CEO} | Collector-emitter voltage | Output, H | -0.5 ~ +35 | V | |
| I_C | Collector current | Current per circuit output, L | 300 | mA | |
| V_I | Input voltage | | -0.5 ~ +35 | V | |
| I_F | Clamping diode forward current | | 300 | mA | |
| V_R | Clamping diode reverse voltage | | 35 | V | |
| P_d | Power dissipation | $T_a = 25^\circ C$, when mounted on board | M63813P | 1.47 | W |
| | | | M63813FP | 1.00 | |
| | | | M63813GP | 0.80 | |
| | | | M63813KP | 0.78 | |
| T_{opr} | Operating temperature | | -40 ~ +85 | $^\circ C$ | |
| T_{stg} | Storage temperature | | -55 ~ +125 | $^\circ C$ | |

PRELIMINARY
 Notice: This is not a final specification.
 Some parametric limits are subject to change.

M63813P/FP/GP/KP

7-UNIT 300mA TRANSISTOR ARRAY WITH CLAMP DIODE

RECOMMENDED OPERATING CONDITIONS (Unless otherwise noted, Ta = -40 ~ +85°C)

| Symbol | Parameter | Test conditions | Limits | | | Unit | |
|--------|---|-----------------|------------------------------|-----|-----|------|----|
| | | | min | typ | max | | |
| Vo | Output voltage | | 0 | — | 35 | V | |
| Ic | Collector current (Current per 1 circuit when 7 circuits are coming on simultaneously) | M63813P | Duty Cycle no more than 45% | 0 | — | 250 | mA |
| | | | Duty Cycle no more than 100% | 0 | — | 160 | |
| | | M63813FP | Duty Cycle no more than 30% | 0 | — | 250 | |
| | | | Duty Cycle no more than 100% | 0 | — | 130 | |
| | | M63813GP | Duty Cycle no more than 24% | 0 | — | 250 | |
| | | | Duty Cycle no more than 100% | 0 | — | 120 | |
| | | M63813KP | Duty Cycle no more than 24% | 0 | — | 250 | |
| | | | Duty Cycle no more than 100% | 0 | — | 120 | |
| VIN | Input voltage | | 0 | — | 20 | V | |

ELECTRICAL CHARACTERISTICS (Unless otherwise noted, Ta = 25°C)

| Symbol | Parameter | Test conditions | Limits | | | Unit |
|----------|--------------------------------------|-----------------------|--------|-----|-----|------|
| | | | min | typ | max | |
| V(BR)CEO | Collector-emitter breakdown voltage | ICEO = 10μA | 35 | — | — | V |
| VCE(sat) | Collector-emitter saturation voltage | IIN = 1mA, IC = 10mA | — | — | 0.2 | V |
| | | IIN = 2mA, IC = 150mA | — | — | 0.8 | |
| VIN(on) | "On" input voltage | IIN = 1mA, IC = 10mA | 2.4 | 35 | 4.2 | V |
| VF | Clamping diode forward voltage | IF = 250mA | — | 1.2 | 2.0 | V |
| IR | Clamping diode reverse current | VR = 35V | — | — | 10 | μA |
| hFE | DC amplification factor | VCE = 10V, IC = 10mA | 50 | — | — | — |

SWITCHING CHARACTERISTICS (Unless otherwise noted, Ta = 25°C)

| Symbol | Parameter | Test conditions | Limits | | | Unit |
|--------|---------------|--------------------|--------|-----|-----|------|
| | | | min | typ | max | |
| ton | Turn-on time | CL = 15pF (note 1) | — | 125 | — | ns |
| toff | Turn-off time | | — | 250 | — | ns |

NOTE 1 TEST CIRCUIT

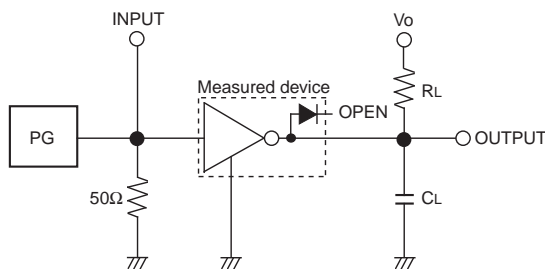

TIMING DIAGRAM

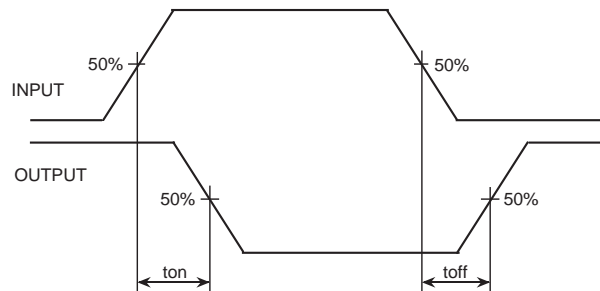

- (1) Pulse generator (PG) characteristics : PRR = 1kHz,
 tw = 10μs, tr = 6ns, tf = 6ns, Zo = 50Ω, VIH = 3V
- (2) Input-output conditions : RL = 220Ω, Vo = 35V
- (3) Electrostatic capacity CL includes floating capacitance at connections and input capacitance at probes

PRELIMINARY
 Notice: This is not a final specification.
 Some parametric limits are subject to change.

TYPICAL CHARACTERISTICS

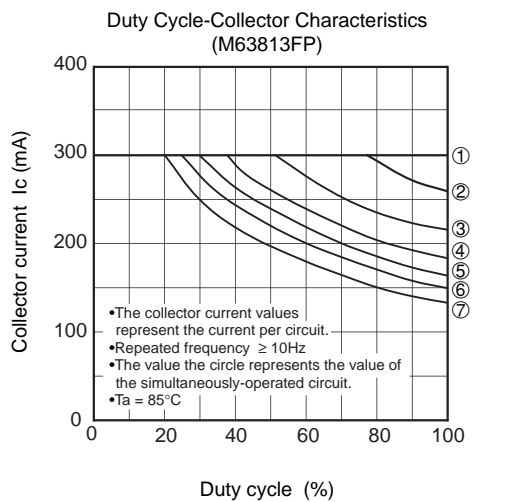
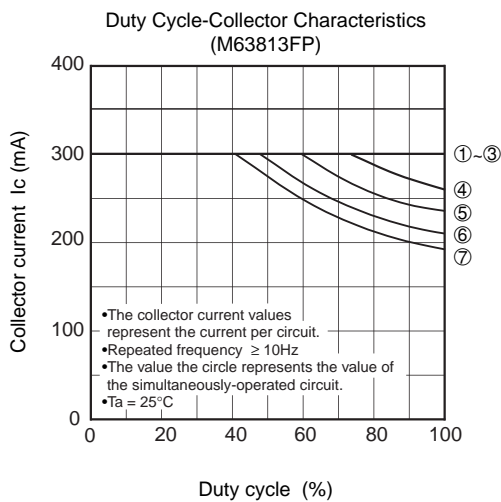
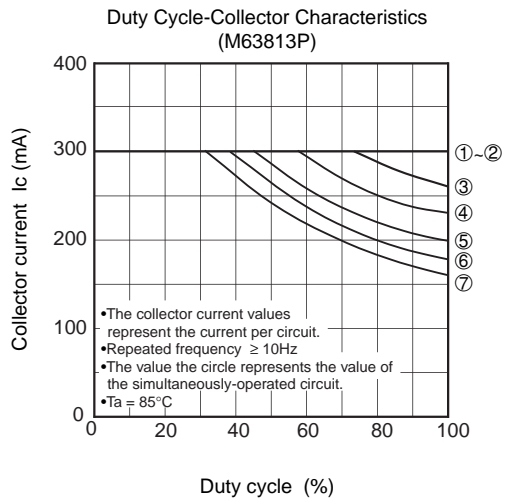
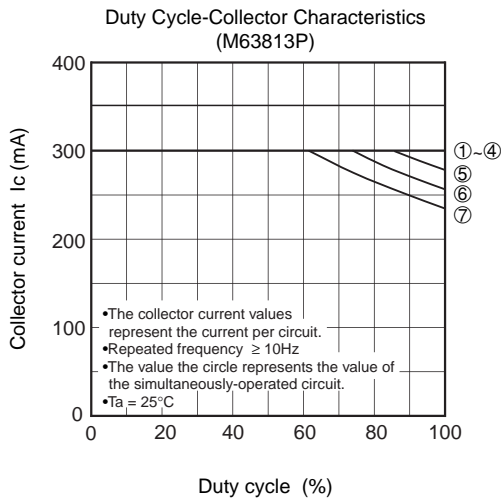
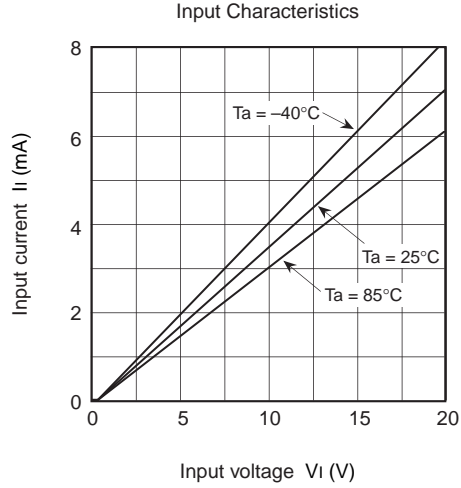
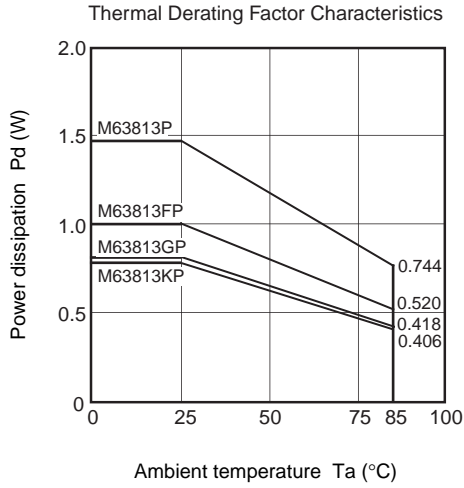

PRELIMINARY
 Notice: This is not a final specification.
 Some parametric limits are subject to change.

M63813P/FP/GP/KP

7-UNIT 300mA TRANSISTOR ARRAY WITH CLAMP DIODE

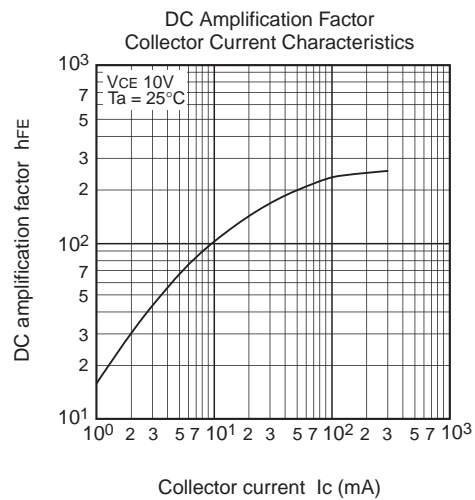
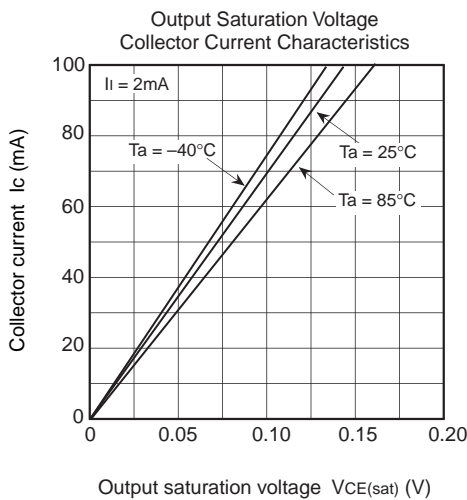
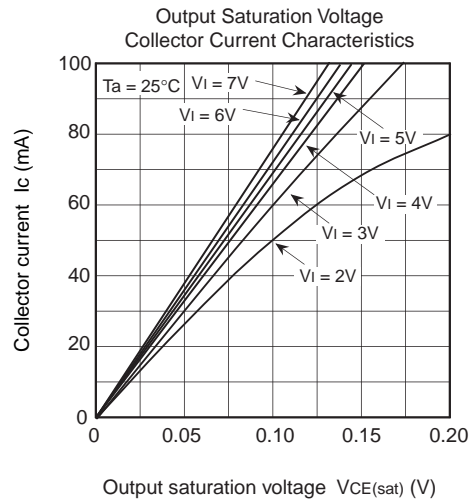
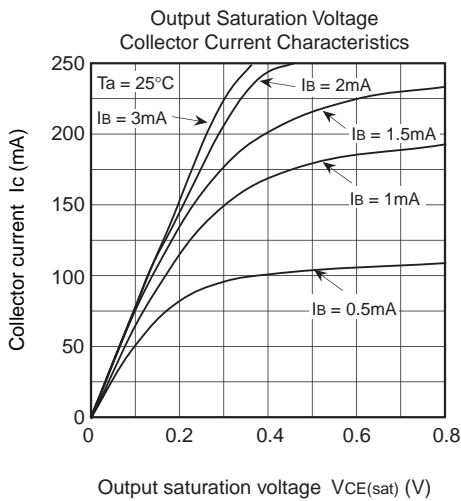
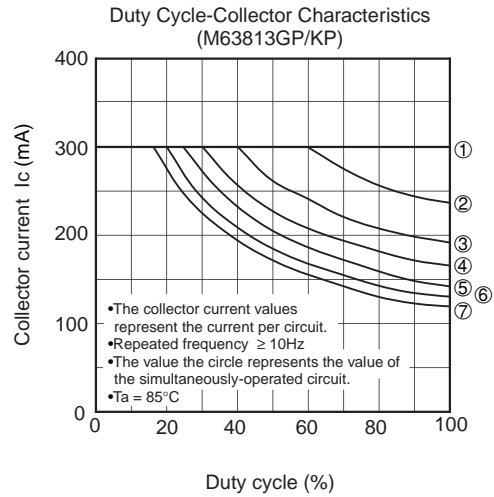
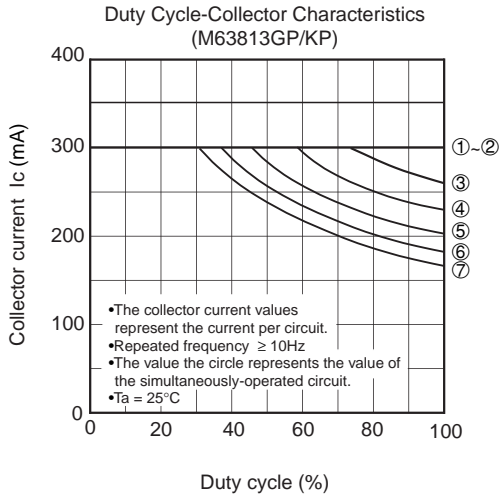

PRELIMINARY
Notice: This is not a final specification.
Some parametric limits are subject to change.

M63813P/FP/GP/KP

7-UNIT 300mA TRANSISTOR ARRAY WITH CLAMP DIODE

