

**PRELIMINARY**  
 Notice: This is not a final specification.  
 Some parametric limits are subject to change.

MITSUBISHI SEMICONDUCTOR <TRANSISTOR ARRAY>

# M63813P/FP/GP/KP

7-UNIT 300mA TRANSISTOR ARRAY WITH CLAMP DIODE

## DESCRIPTION

M63813P/FP/GP/KP are seven-circuit Single transistor arrays with clamping diodes. The circuits are made of NPN transistors. Both the semiconductor integrated circuits perform high-current driving with extremely low input-current supply.

## FEATURES

- Four package configurations (P, FP, GP and KP)
- Medium breakdown voltage ( $BV_{CEO} \geq 35V$ )
- Synchronizing current ( $I_{C(max)} = 300mA$ )
- With clamping diodes
- Low output saturation voltage
- Wide operating temperature range ( $T_a = -40$  to  $+85^\circ C$ )

## APPLICATION

Driving of digit drives of indication elements (LEDs and lamps) with small signals

## FUNCTION

The M63813P/FP/GP/KP each have seven circuits consisting of NPN transistor. A spike-killer clamping diode is provided between each output pin (collector) and COM pin (pin9). The transistor emitters are all connected to the GND pin (pin 8). The transistors allow synchronous flow of 300mA collector current. A maximum of 35V voltage can be applied between the collector and emitter.

## PIN CONFIGURATION

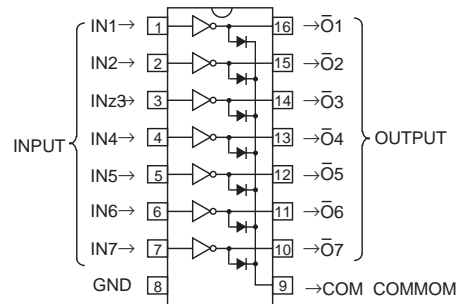

Package type  
 16P4(P)  
 16P2N-A(FP)  
 16P2S-A(GP)  
 16P2Z-A(KP)

## CIRCUIT DIAGRAM

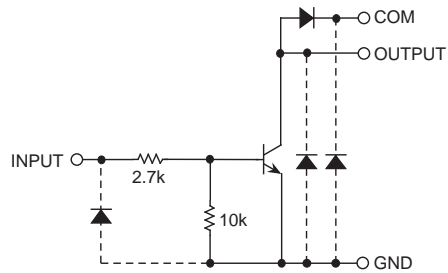

The seven circuits share the COM and GND.  
 The diode, indicated with the dotted line, is parasitic, and cannot be used.

Unit:  $\Omega$

## ABSOLUTE MAXIMUM RATINGS (Unless otherwise noted, $T_a = -40 \sim +85^\circ C$ )

Symbol	Parameter	Conditions	Ratings	Unit	
$V_{CEO}$	Collector-emitter voltage	Output, H	-0.5 ~ +35	V	
$I_C$	Collector current	Current per circuit output, L	300	mA	
$V_I$	Input voltage		-0.5 ~ +35	V	
$I_F$	Clamping diode forward current		300	mA	
$V_R$	Clamping diode reverse voltage		35	V	
$P_d$	Power dissipation	$T_a = 25^\circ C$ , when mounted on board	M63813P	1.47	W
			M63813FP	1.00	
			M63813GP	0.80	
			M63813KP	0.78	
$T_{opr}$	Operating temperature		-40 ~ +85	$^\circ C$	
$T_{stg}$	Storage temperature		-55 ~ +125	$^\circ C$	

**PRELIMINARY**  
 Notice: This is not a final specification.  
 Some parametric limits are subject to change.

**M63813P/FP/GP/KP**

7-UNIT 300mA TRANSISTOR ARRAY WITH CLAMP DIODE

**RECOMMENDED OPERATING CONDITIONS** (Unless otherwise noted, Ta = -40 ~ +85°C)

Symbol	Parameter	Test conditions	Limits			Unit	
			min	typ	max		
Vo	Output voltage		0	—	35	V	
Ic	Collector current (Current per 1 circuit when 7 circuits are coming on simultaneously)	M63813P	Duty Cycle no more than 45%	0	—	250	mA
			Duty Cycle no more than 100%	0	—	160	
		M63813FP	Duty Cycle no more than 30%	0	—	250	
			Duty Cycle no more than 100%	0	—	130	
		M63813GP	Duty Cycle no more than 24%	0	—	250	
			Duty Cycle no more than 100%	0	—	120	
		M63813KP	Duty Cycle no more than 24%	0	—	250	
			Duty Cycle no more than 100%	0	—	120	
VIN	Input voltage		0	—	20	V	

**ELECTRICAL CHARACTERISTICS** (Unless otherwise noted, Ta = 25°C)

Symbol	Parameter	Test conditions	Limits			Unit
			min	typ	max	
V(BR)CEO	Collector-emitter breakdown voltage	ICEO = 10μA	35	—	—	V
VCE(sat)	Collector-emitter saturation voltage	IIN = 1mA, IC = 10mA	—	—	0.2	V
		IIN = 2mA, IC = 150mA	—	—	0.8	
VIN(on)	"On" input voltage	IIN = 1mA, IC = 10mA	2.4	35	4.2	V
VF	Clamping diode forward voltage	IF = 250mA	—	1.2	2.0	V
IR	Clamping diode reverse current	VR = 35V	—	—	10	μA
hFE	DC amplification factor	VCE = 10V, IC = 10mA	50	—	—	—

**SWITCHING CHARACTERISTICS** (Unless otherwise noted, Ta = 25°C)

Symbol	Parameter	Test conditions	Limits			Unit
			min	typ	max	
ton	Turn-on time	CL = 15pF (note 1)	—	125	—	ns
toff	Turn-off time		—	250	—	ns

**NOTE 1 TEST CIRCUIT**

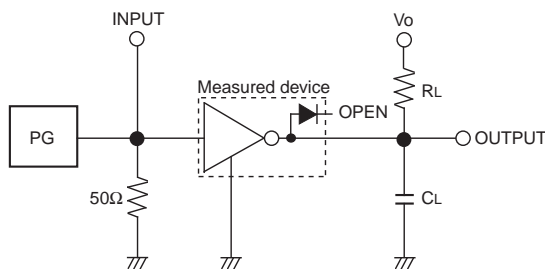

- (1) Pulse generator (PG) characteristics : PRR = 1kHz, tw = 10μs, tr = 6ns, tf = 6ns, Zo = 50Ω, VIH = 3V
- (2) Input-output conditions : RL = 220Ω, Vo = 35V
- (3) Electrostatic capacity CL includes floating capacitance at connections and input capacitance at probes

**TIMING DIAGRAM**

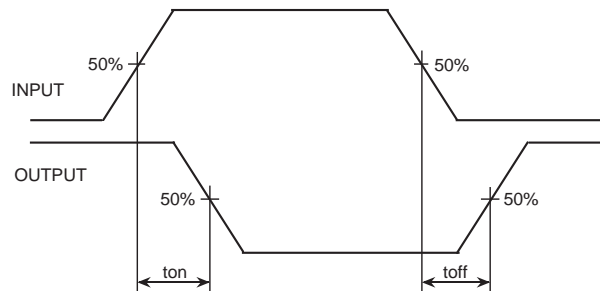

**PRELIMINARY**  
 Notice: This is not a final specification.  
 Some parametric limits are subject to change.

**TYPICAL CHARACTERISTICS**

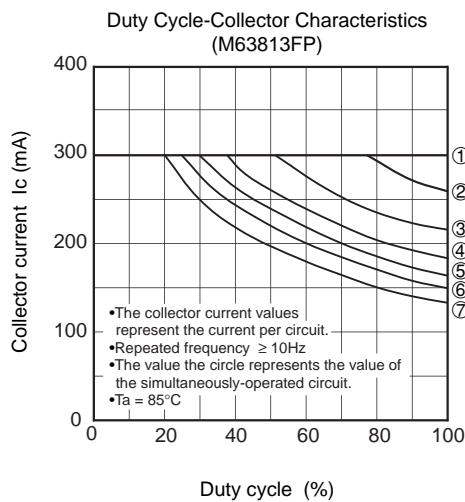
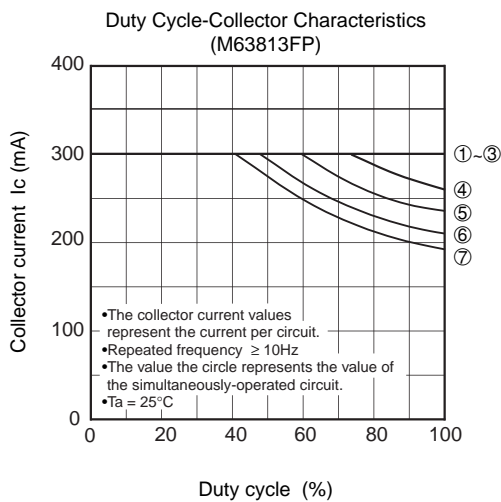
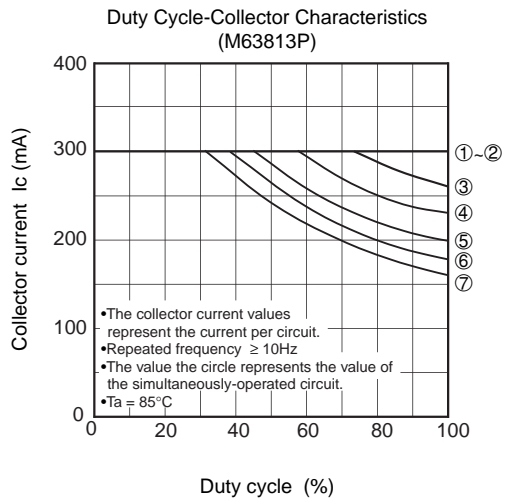
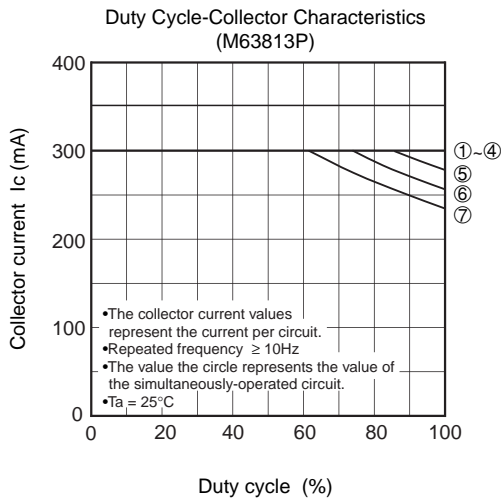
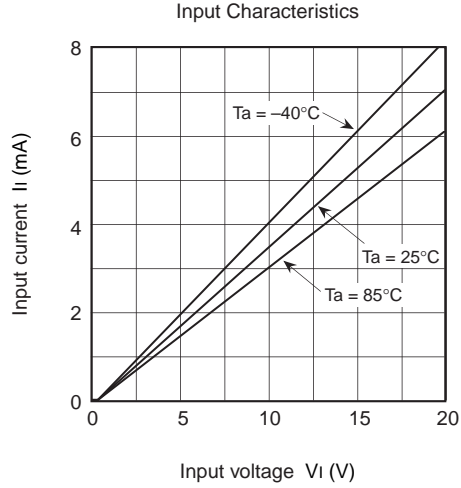
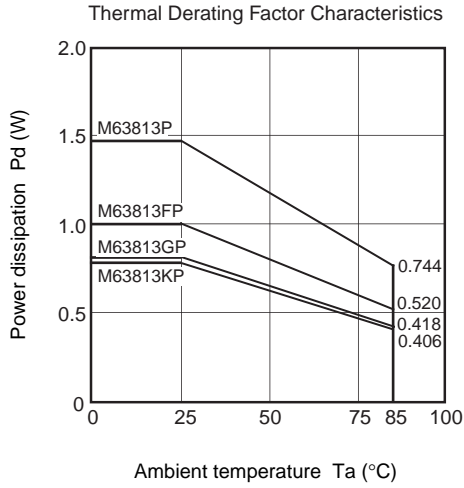

**PRELIMINARY**  
 Notice: This is not a final specification.  
 Some parametric limits are subject to change.

**M63813P/FP/GP/KP**

7-UNIT 300mA TRANSISTOR ARRAY WITH CLAMP DIODE

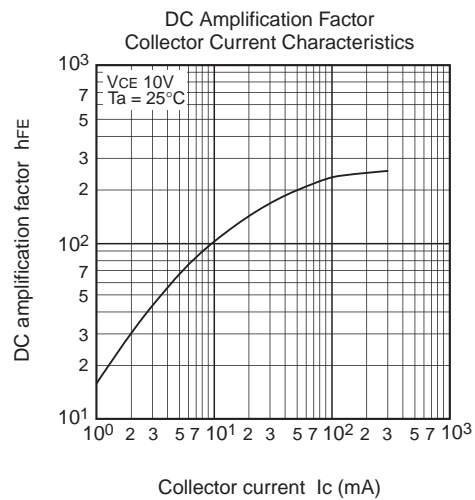
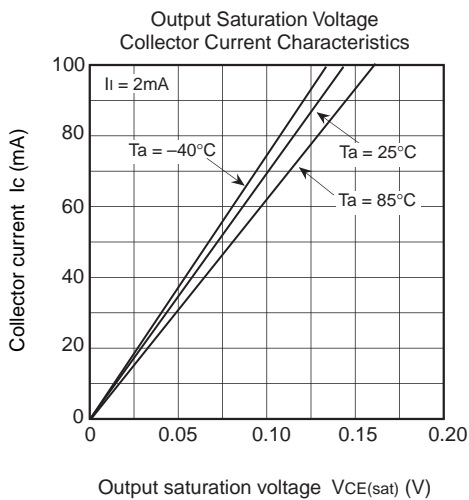
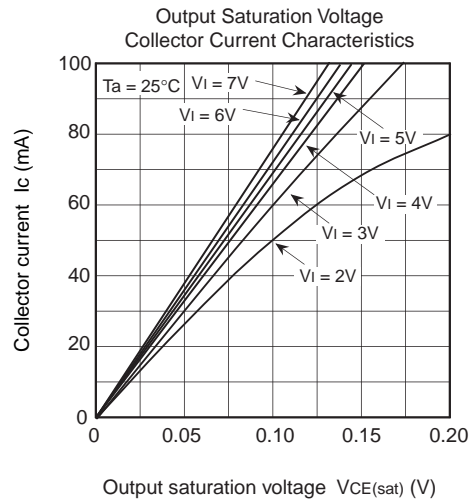
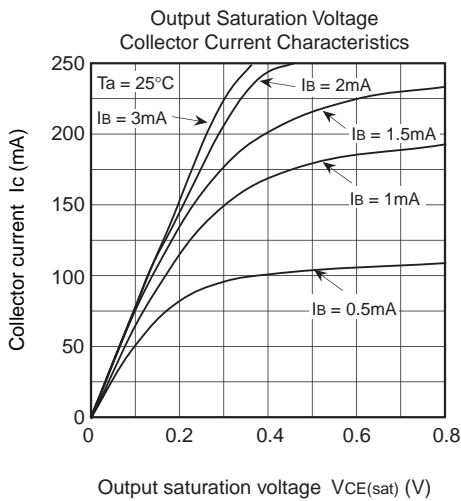
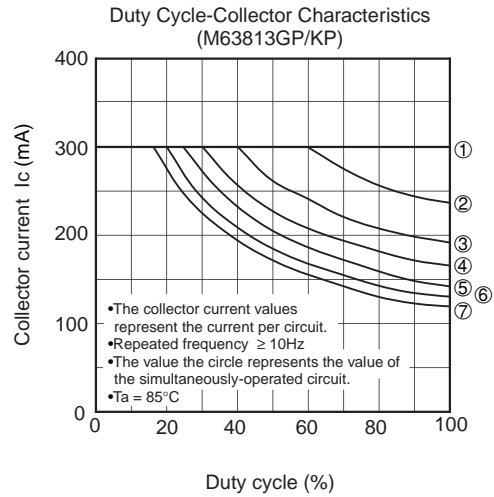
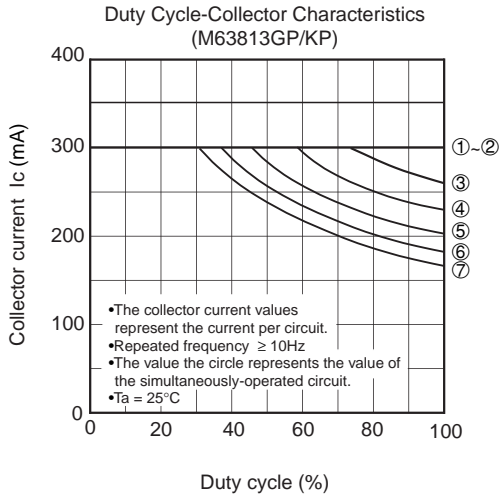

**PRELIMINARY**  
 Notice: This is not a final specification.  
 Some parametric limits are subject to change.

**M63813P/FP/GP/KP**

7-UNIT 300mA TRANSISTOR ARRAY WITH CLAMP DIODE

Grounded Emitter Transfer Characteristics

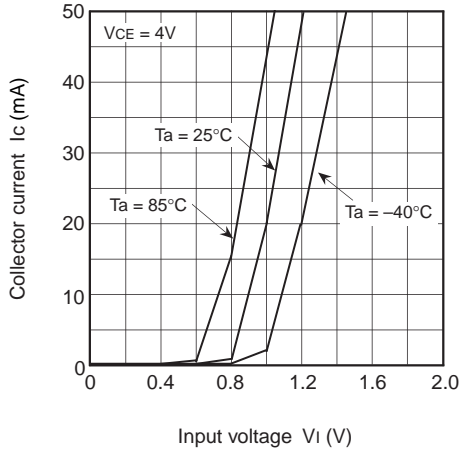

Grounded Emitter Transfer Characteristics

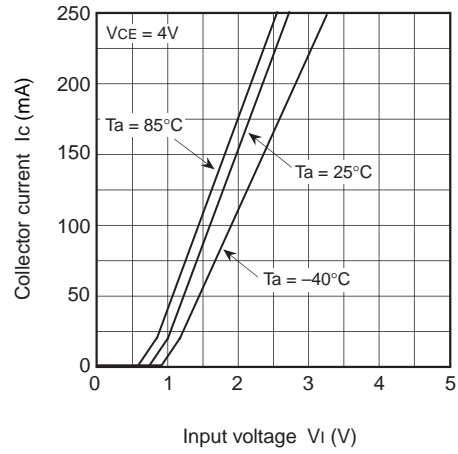

Clamping Diode Characteristics

