

**PRELIMINARY**  
 Notice: This is not a final specification.  
 Some parametric limits are subject to change.

MITSUBISHI SEMICONDUCTOR <TRANSISTOR ARRAY>

# M63806P/FP/KP

8-UNIT 300mA TRANSISTOR ARRAY

## DESCRIPTION

M63806P/FP/KP are eight-circuit Single transistor arrays. The circuits are made of NPN transistors. Both the semiconductor integrated circuits perform high-current driving with extremely low input-current supply.

## FEATURES

- Three package configurations (P, FP, and KP)
- Medium breakdown voltage ( $BV_{CEO} \geq 35V$ )
- Synchronizing current ( $I_{C(max)} = 300mA$ )
- Low output saturation voltage
- Wide operating temperature range ( $T_a = -40$  to  $+85^\circ C$ )

## APPLICATION

Driving of digit drives of indication elements (LEDs and lamps) with small signals

## FUNCTION

The M63806P/FP/KP each have eight circuits consisting of NPN transistor. The transistor emitters are all connected to the GND pin. The transistors allow synchronous flow of 300mA collector current. A maximum of 35V voltage can be applied between the collector and emitter.

## PIN CONFIGURATION

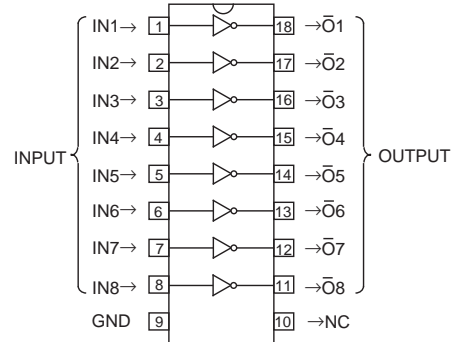

Package type 18P4G(P)

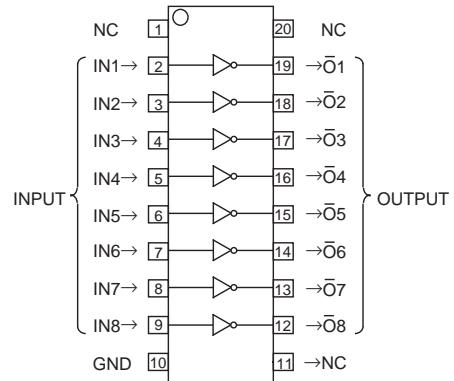

NC : No connection

20P2N-A(FP)

Package type 20P2E-A(KP)

## CIRCUIT DIAGRAM

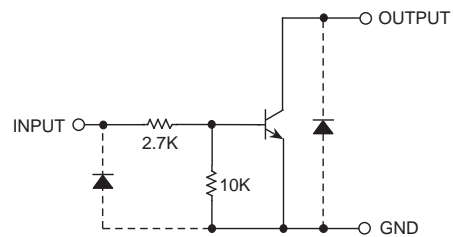

The eight circuits share the GND.

The diode, indicated with the dotted line, is parasitic, and cannot be used.

Unit:  $\Omega$

**PRELIMINARY**  
 Notice: This is not a final specification.  
 Some parametric limits are subject to change.

**M63806P/FP/KP**

8-UNIT 300mA TRANSISTOR ARRAY

**ABSOLUTE MAXIMUM RATINGS** (Unless otherwise noted, Ta = -40 ~ +85°C)

Symbol	Parameter	Conditions	Ratings	Unit	
V <sub>CEO</sub>	Collector-emitter voltage	Output, H	-0.5 ~ +35	V	
I <sub>C</sub>	Collector current	Current per circuit output, L	300	mA	
V <sub>I</sub>	Input voltage		-0.5 ~ +35	V	
P <sub>d</sub>	Power dissipation	Ta = 25°C, when mounted on board	M63806P	1.79	W
			M63806FP	1.10	
			M63806KP	0.68	
T <sub>opr</sub>	Operating temperature		-40 ~ +85	°C	
T <sub>stg</sub>	Storage temperature		-55 ~ +125	°C	

**RECOMMENDED OPERATING CONDITIONS** (Unless otherwise noted, Ta = -40 ~ +85°C)

Symbol	Parameter	Test conditions	Limits			Unit	
			min	typ	max		
V <sub>O</sub>	Output voltage		0	—	35	V	
I <sub>C</sub>	Collector current (Current per 1 circuit when 8 circuits are coming on simultaneously)	M63806P	Duty Cycle no more than 50%	0	—	250	mA
			Duty Cycle no more than 100%	0	—	170	
		M63806FP	Duty Cycle no more than 30%	0	—	250	
			Duty Cycle no more than 100%	0	—	130	
		M63806KP	Duty Cycle no more than 12%	0	—	250	
			Duty Cycle no more than 100%	0	—	100	
V <sub>IN</sub>	Input voltage		0	—	20	V	

**ELECTRICAL CHARACTERISTICS** (Unless otherwise noted, Ta = 25°C)

Symbol	Parameter	Test conditions	Limits			Unit
			min	typ	max	
V (BR) CEO	Collector-emitter breakdown voltage	I <sub>CEO</sub> = 10μA	35	—	—	V
V <sub>CE(sat)</sub>	Collector-emitter saturation voltage	I <sub>IN</sub> = 1mA, I <sub>C</sub> = 10mA	—	—	0.2	V
		I <sub>IN</sub> = 2mA, I <sub>C</sub> = 150mA	—	—	0.8	
V <sub>IN(on)</sub>	"On" input voltage	I <sub>IN</sub> = 1mA, I <sub>C</sub> = 10mA	2.4	3.5	4.2	V
h <sub>FE</sub>	DC amplification factor	V <sub>CE</sub> = 10V, I <sub>C</sub> = 10mA	50	—	—	—

**SWITCHING CHARACTERISTICS** (Unless otherwise noted, Ta = 25°C)

Symbol	Parameter	Test conditions	Limits			Unit
			min	typ	max	
t <sub>on</sub>	Turn-on time	C <sub>L</sub> = 15pF (note 1)	—	125	—	ns
t <sub>off</sub>	Turn-off time		—	250	—	ns

**PRELIMINARY**  
 Notice: This is not a final specification.  
 Some parametric limits are subject to change.

**M63806P/FP/KP**

8-UNIT 300mA TRANSISTOR ARRAY

**NOTE 1 TEST CIRCUIT**

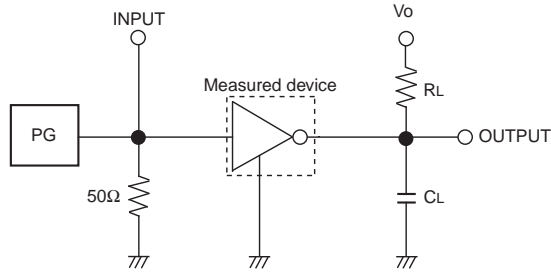

- (1) Pulse generator (PG) characteristics : PRR = 1kHz,  $t_w = 10\mu s$ ,  $t_r = 6ns$ ,  $t_f = 6ns$ ,  $Z_o = 50\Omega$ ,  $V_{IH} = 3V$
- (2) Input-output conditions :  $R_L = 220\Omega$ ,  $V_o = 35V$
- (3) Electrostatic capacity  $C_L$  includes floating capacitance at connections and input capacitance at probes

**TIMING DIAGRAM**

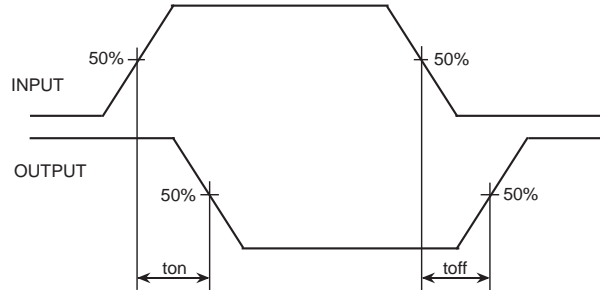

**TYPICAL CHARACTERISTICS**

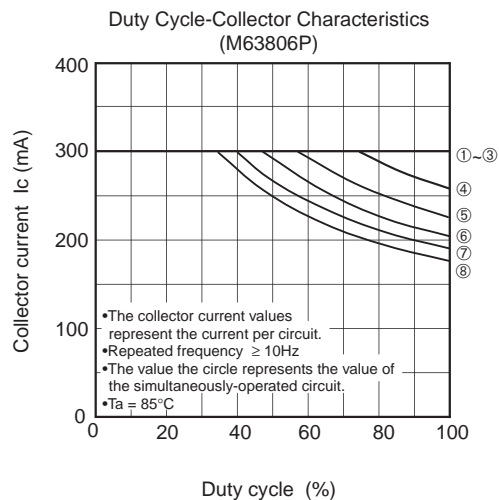
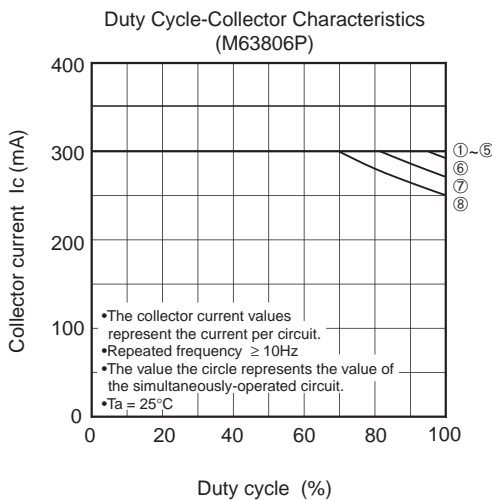
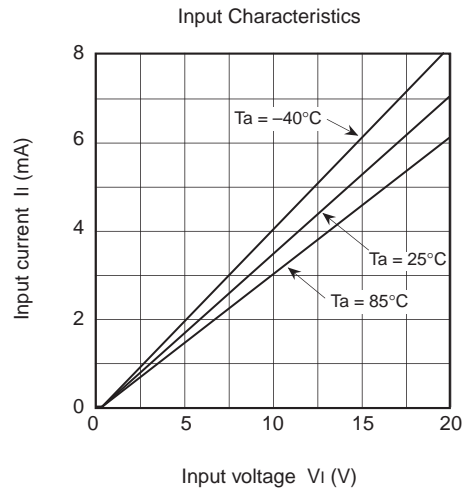
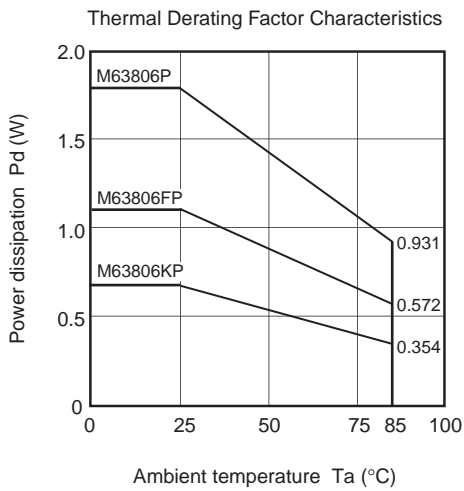

**PRELIMINARY**  
 Notice: This is not a final specification.  
 Some parametric limits are subject to change.

**M63806P/FP/KP**

8-UNIT 300mA TRANSISTOR ARRAY

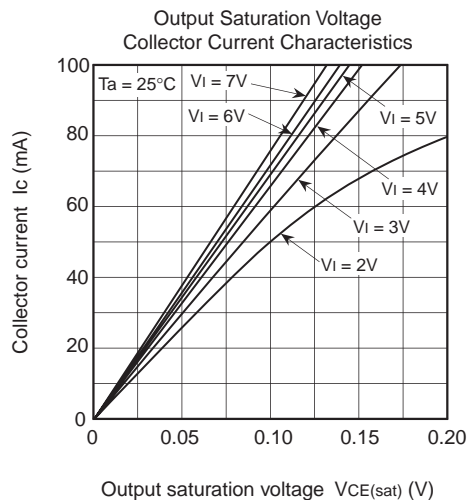
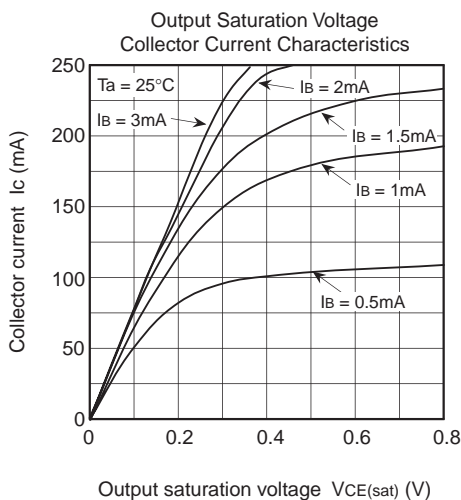
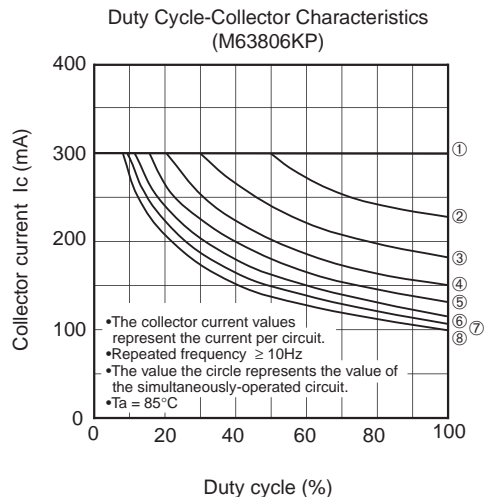
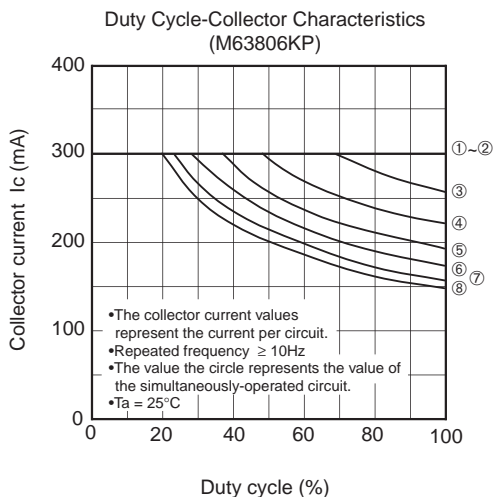
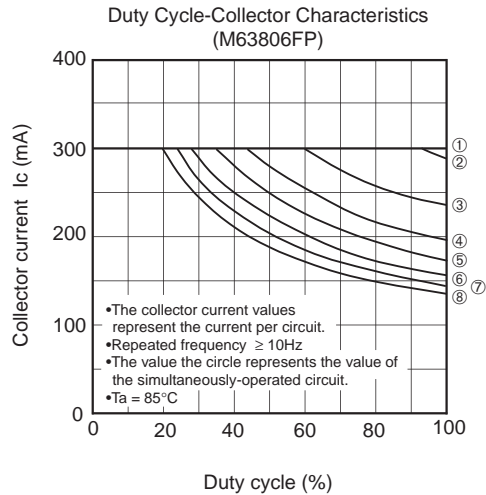
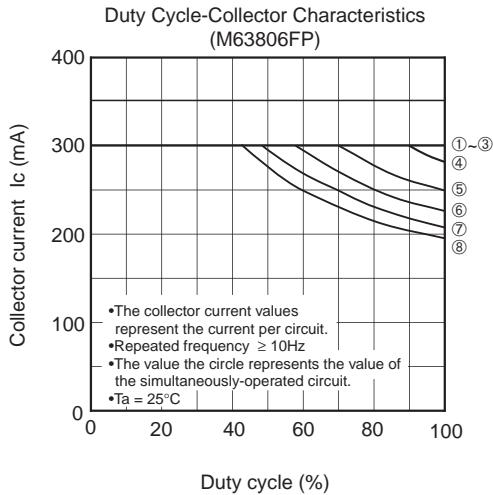

**PRELIMINARY**  
 Notice: This is not a final specification.  
 Some parametric limits are subject to change.

**M63806P/FP/KP**

8-UNIT 300mA TRANSISTOR ARRAY

