

M54585KP

8-UNIT 500mA DARLINGTON TRANSISTOR-ARRAY WITH CLAMP DIODE

DESCRIPTION

M54585KP is eight-circuit Darlington transistor arrays with clamping diodes. The circuits are made of NPN transistors. Both the semiconductor integrated circuits perform high-current driving with extremely low input-current supply.

FEATURES

- High breakdown voltage ($BV_{CEO} \geq 50V$)
- High-current driving ($I_{C(max)} = 500mA$)
- With clamping diodes
- Driving available with TTL output or with PMOS IC output
- With shrink small outline package

APPLICATION

Drives of relays and printers, digit drives of indication elements such as LEDs and lamps, and MOS-bipolar logic IC interfaces

FUNCTION

The M54585KP has eight circuits, which are NPN Darlington transistors. Input transistors have resistance of $2.7k\Omega$ between the base and input pin. A spike-killer clamping diode is provided between each output pin and GND. Output transistor emitters are all connected to the GND pin. Collector current is 500mA maximum. The maximum collector-emitter voltage is 50V.

PIN CONFIGURATION

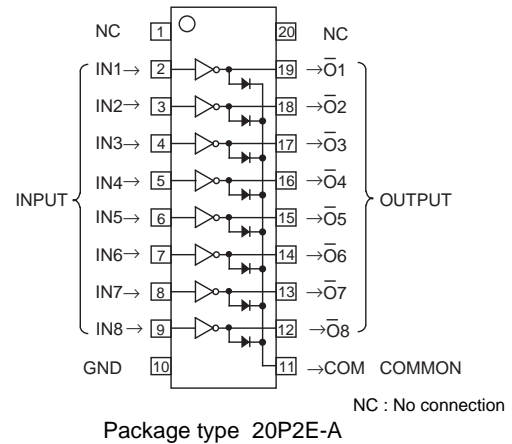

CIRCUIT DIAGRAM

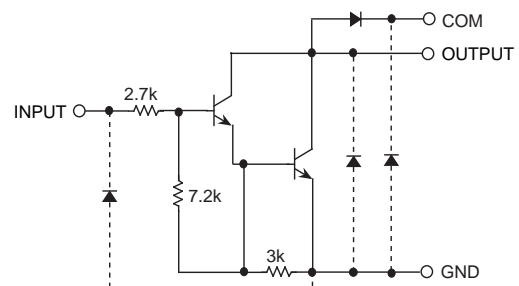

The eight circuits share the COM and GND.

The diode, indicated with the dotted line, is parasitic, and cannot be used.

Unit : Ω

ABSOLUTE MAXIMUM RATINGS (Unless otherwise noted, $T_a = -20 \sim +75^\circ C$)

Symbol	Parameter	Conditions	Ratings	Unit
V_{CEO}	Collector-emitter voltage	Output, H	-0.5 ~ +50	V
I_C	Collector current	Current per circuit output, L	500	mA
V_I	Input voltage		-0.5 ~ +30	V
I_F	Clamping diode forward current		500	mA
V_R	Clamping diode reverse voltage		50	V
P_d	Power dissipation	$T_a = 25^\circ C$, when mounted on board	0.68	W
T_{opr}	Operating temperature		-20 ~ +75	$^\circ C$
T_{stg}	Storage temperature		-55 ~ +125	$^\circ C$

M54585KP

8-UNIT 500mA DARLINGTON TRANSISTOR-ARRAY WITH CLAMP DIODE

RECOMMENDED OPERATING CONDITIONS (Unless otherwise noted, Ta = -20 ~ +75°C)

Symbol	Parameter	Limits			Unit	
		min	typ	max		
Vo	Output voltage	0	—	50	V	
Ic	Collector current (Current per 1 circuit when 8 circuits are coming on simultaneously)	Duty Cycle ≤ 10%	0	—	200	mA
		Duty Cycle ≤ 50%	0	—	70	
VIH	"H" input voltage	Ic ≤ 400mA	3.85	—	30	V
		Ic ≤ 200mA	3.4	—	30	V
VIL	"L" input voltage	0	—	0.6	V	

ELECTRICAL CHARACTERISTICS (Unless otherwise noted, Ta = -20 ~ +75°C)

Symbol	Parameter	Test conditions	Limits			Unit
			min	typ*	max	
V (BR) CEO	Collector-emitter breakdown voltage	ICEO = 100μA	50	—	—	V
VCE(sat)	Collector-emitter saturation voltage	VI = 3.85V, IC = 400mA	—	1.3	2.4	V
		VI = 3.4V, IC = 200mA	—	1.0	1.6	
II	Input current	II = 3.85V	—	0.95	1.8	mA
		VI = 25V	—	8.7	18	
VF	Clamping diode forward voltage	IF = 400mA	—	1.5	2.4	V
IR	Clamping diode reverse current	VR = 50V	—	—	100	μA
hFE	DC amplification factor	VCE = 4V, IC = 350mA, Ta = 25°C	1000	2500	—	—

* : The typical values are those measured under ambient temperature (Ta) of 25°C. There is no guarantee that these values are obtained under any conditions.

SWITCHING CHARACTERISTICS (Unless otherwise noted, Ta = 25°C)

Symbol	Parameter	Test conditions	Limits			Unit
			min	typ	max	
ton	Turn-on time	CL = 15pF (note 1)	—	12	—	ns
toff	Turn-off time		—	240	—	ns

NOTE 1 TEST CIRCUIT

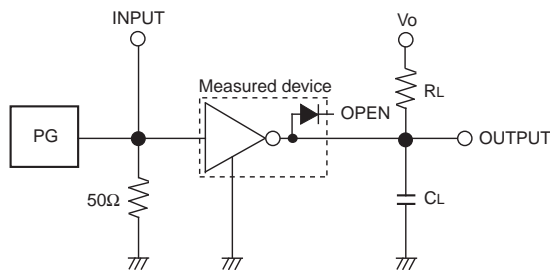

- (1) Pulse generator (PG) characteristics : PRR = 1kHz,
tw = 10μs, tr = 6ns, tf = 6ns, Zo = 50Ω,
VI = 3.85V
- (2) Input-output conditions : RL = 25Ω, Vo = 10V
- (3) Electrostatic capacity CL includes floating capacitance at connections and input capacitance at probes

TIMING DIAGRAM

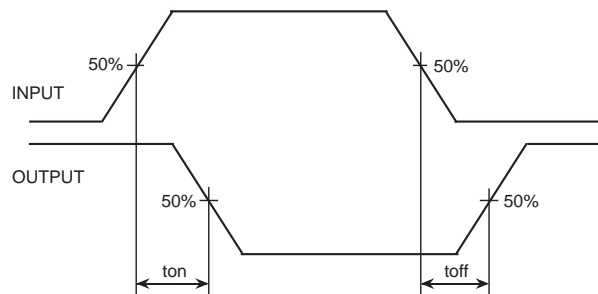

TYPICAL CHARACTERISTICS

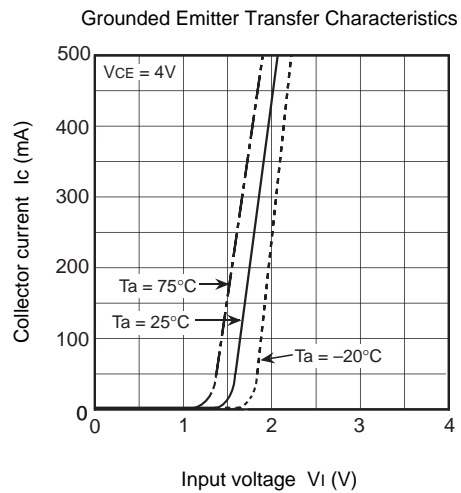
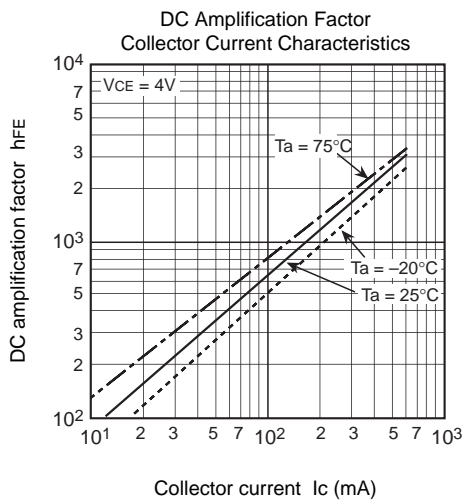
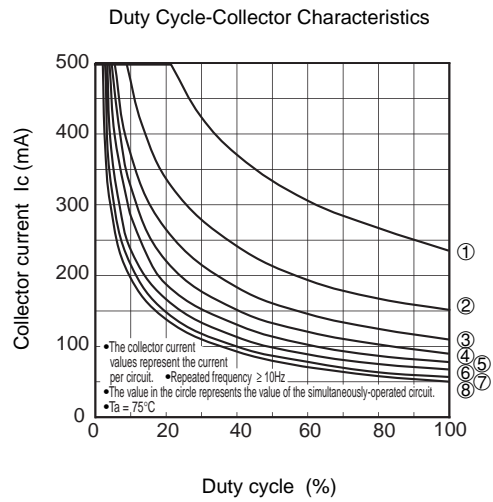
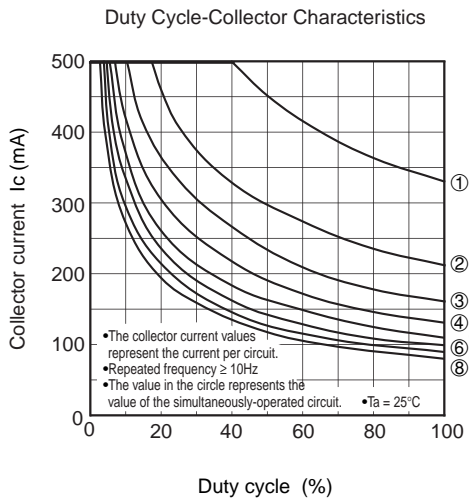
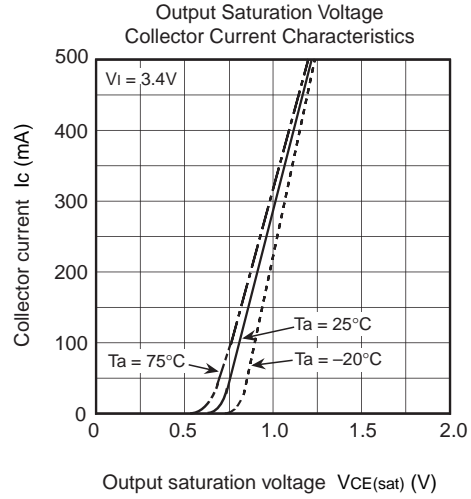
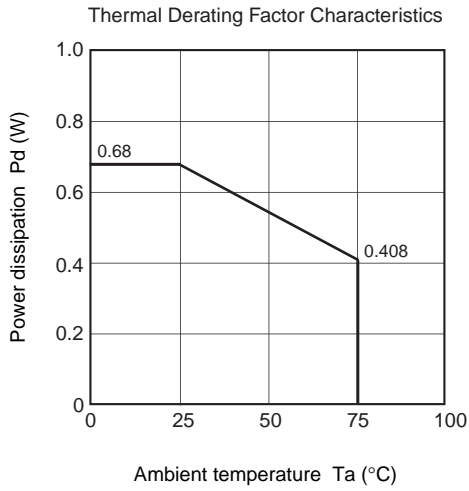

M54585KP

8-UNIT 500mA DARLINGTON TRANSISTOR-ARRAY WITH CLAMP DIODE

