

# M54583P/FP

8-UNIT 400mA DARLINGTON TRANSISTOR ARRAY

## DESCRIPTION

M54583P and M54583FP are eight-circuit collector-current-synchronized Darlington transistor arrays. The circuits are made of PNP and NPN transistors. Both the semiconductor integrated circuits perform high-current driving with extremely low input-current supply.

## FEATURES

- High breakdown voltage ( $BV_{CEO} \geq 50V$ )
- High-current driving ( $I_{c(max)} = 400mA$ )
- Active L-level input
- With input clamping diodes

## APPLICATION

Interfaces between microcomputers and high-voltage, high-current drive systems, drives of relays and printers, and MOS-bipolar logic IC interfaces

## FUNCTION

The M54583 is produced by adding PNP transistors to M54523 inputs. Eight circuits having active L-level inputs are provided.

Resistance of  $7k\Omega$  and diode are provided in series between each input and PNP transistor base. The input diode is intended to prevent the flow of current from the input to the  $V_{cc}$ . Without this diode, the current flow from "H" input to the  $V_{cc}$  and the "L" input circuits is activated, in such case where one of the inputs of the 8 circuits is "H" and the others are "L" to save power consumption. The diode is inserted to prevent such misoperation.

This device is most suitable for a driver using NMOS IC output especially for the driver of current sink.

Collector current is 400mA maximum. Collector-emitter supply voltage is 50V.

The 54583FP is enclosed in a molded small flat package, enabling space saving design.

## PIN CONFIGURATION (TOP VIEW)

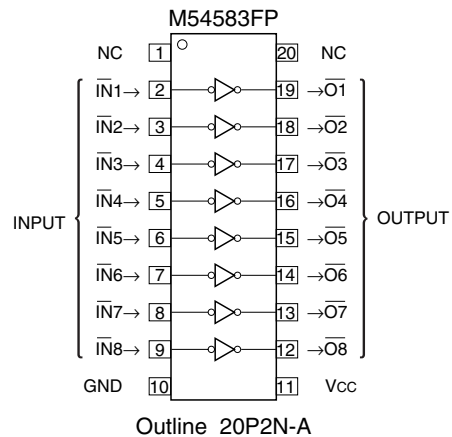
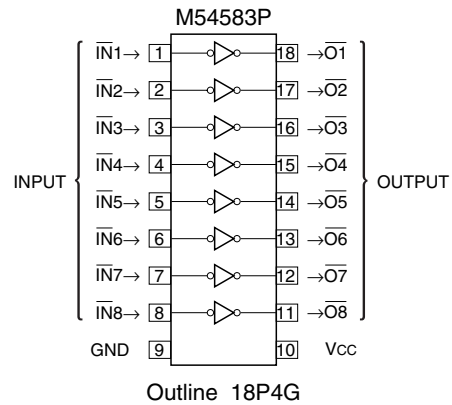

NC : No connection

## CIRCUIT DIAGRAM (EACH CIRCUIT)

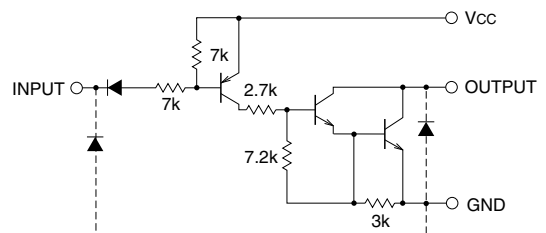

The eight circuits share the  $V_{cc}$  and GND.

The diode, indicated with the dotted line, is parasitic, and cannot be used.

Unit :  $\Omega$

# M54583P/FP

## 8-UNIT 400mA DARLINGTON TRANSISTOR ARRAY

### ABSOLUTE MAXIMUM RATINGS (Unless otherwise noted, Ta = -20 ~ +75°C)

Symbol	Parameter	Conditions	Ratings	Unit
V <sub>CC</sub>	Supply voltage		10	V
V <sub>CEO</sub>	Collector-emitter voltage	Output, H	-0.5 ~ +50	V
V <sub>I</sub>	Input voltage		-0.5 ~ V <sub>CC</sub>	V
I <sub>C</sub>	Collector current	Current per circuit output, L	400	mA
P <sub>d</sub>	Power dissipation	Ta = 25°C, when mounted on board	1.79/1.1	W
T <sub>opr</sub>	Operating temperature		-20 ~ +75	°C
T <sub>stg</sub>	Storage temperature		-55 ~ +125	°C

### RECOMMENDED OPERATING CONDITIONS (Unless otherwise noted, Ta = -20 ~ +75°C)

Symbol	Parameter	Limits			Unit	
		min	typ	max		
V <sub>CC</sub>	Supply voltage	4	5	8	V	
I <sub>C</sub>	Collector current Per channel	V <sub>CC</sub> = 5V, Duty Cycle P : no more than 10% FP : no more than 5%	0	—	350	mA
		V <sub>CC</sub> = 5V, Duty Cycle P : no more than 34% FP : no more than 15%	0	—	200	
V <sub>IH</sub>	"H" input voltage	V <sub>CC</sub> -0.7	—	V <sub>CC</sub>	V	
V <sub>IL</sub>	"L" input voltage	0	—	V <sub>CC</sub> -3.6	V	

### ELECTRICAL CHARACTERISTICS (Unless otherwise noted, Ta = -20 ~ +75°C)

Symbol	Parameter	Test conditions	Limits			Unit	
			min	typ*	max		
V <sub>(BR)CEO</sub>	Collector-emitter breakdown voltage	I <sub>CEO</sub> = 100μA, V <sub>CC</sub> = 8V	50	—	—	V	
V <sub>CE(sat)</sub>	Collector-emitter saturation voltage	V <sub>I</sub> = V <sub>CC</sub> -3.6V	I <sub>C</sub> = 350mA	—	1.2	2.2	V
			I <sub>C</sub> = 200mA	—	0.98	1.6	
I <sub>I</sub>	Input current	V <sub>I</sub> = V <sub>CC</sub> -3.6V	—	-320	-600	μA	
I <sub>CC</sub>	Supply current (one circuit coming on)	V <sub>CC</sub> = 5V, V <sub>I</sub> = V <sub>CC</sub> -3.6V	—	1.9	3	mA	
h <sub>FE</sub>	DC amplification factor	V <sub>CE</sub> = 4V, V <sub>CC</sub> = 5V, I <sub>C</sub> = 350mA, Ta = 25°C	2000	3500	—	—	

\* : The typical values are those measured under ambient temperature (Ta) of 25°C. There is no guarantee that these values are obtained under any conditions.

### SWITCHING CHARACTERISTICS (Unless otherwise noted, Ta = 25°C)

Symbol	Parameter	Test conditions	Limits			Unit
			min	typ	max	
t <sub>on</sub>	Turn-on time	C <sub>L</sub> = 15pF (note 1)	—	130	—	ns
t <sub>off</sub>	Turn-off time		—	3200	—	ns

### NOTE 1 TEST CIRCUIT

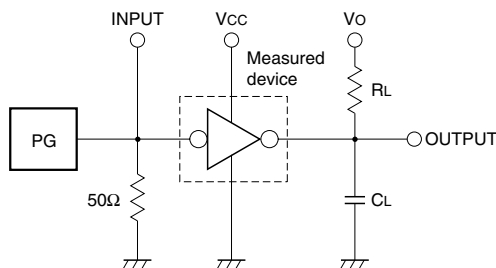

- (1) Pulse generator (PG) characteristics : PRR = 1kHz, t<sub>w</sub> = 10μs, t<sub>r</sub> = 6ns, t<sub>f</sub> = 6ns, Z<sub>0</sub> = 50Ω, V<sub>I</sub> = 0.4 to 4V
- (2) Input-output conditions : R<sub>L</sub> = 30Ω, V<sub>O</sub> = 10V, V<sub>CC</sub> = 4V
- (3) Electrostatic capacity C<sub>L</sub> includes floating capacitance at connections and input capacitance at probes

### TIMING DIAGRAM

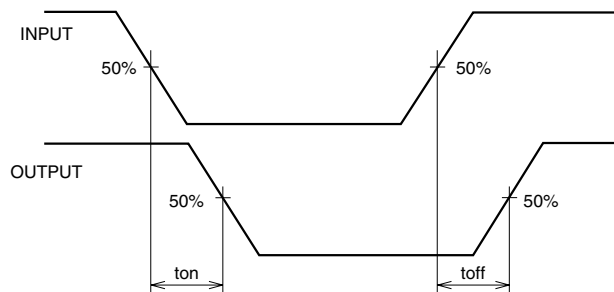

M54583P/FP

8-UNIT 400mA DARLINGTON TRANSISTOR ARRAY

TYPICAL CHARACTERISTICS

Thermal Derating Factor Characteristics

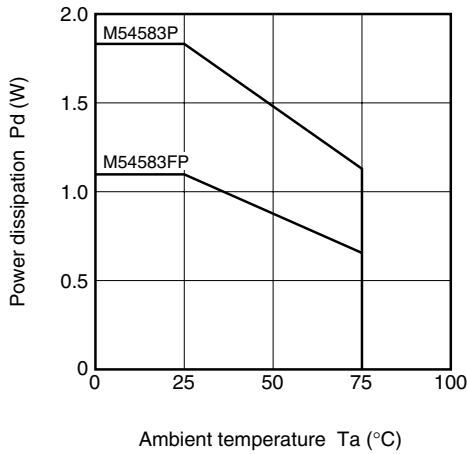

Output Saturation Voltage Collector Current Characteristics

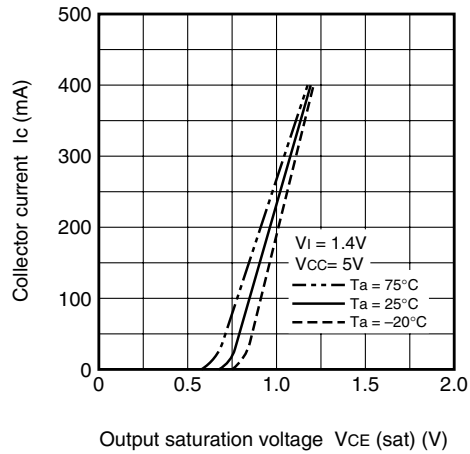

Duty-Cycle-Collector Characteristics (M54583P)

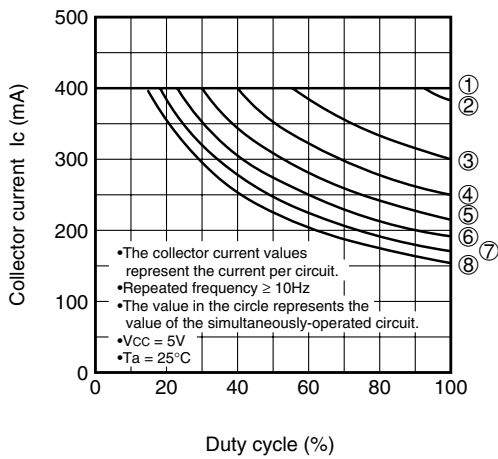

Duty-Cycle-Collector Characteristics (M54583P)

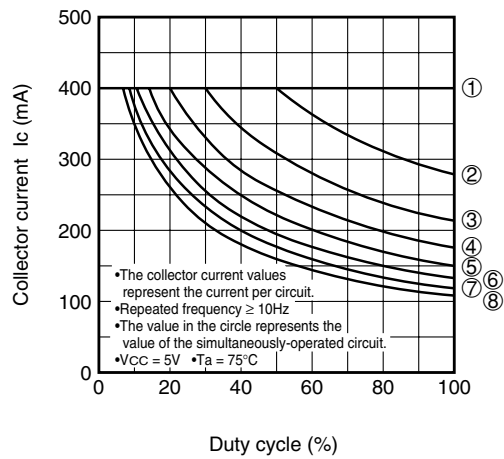

Duty-Cycle-Collector Characteristics (M54583FP)

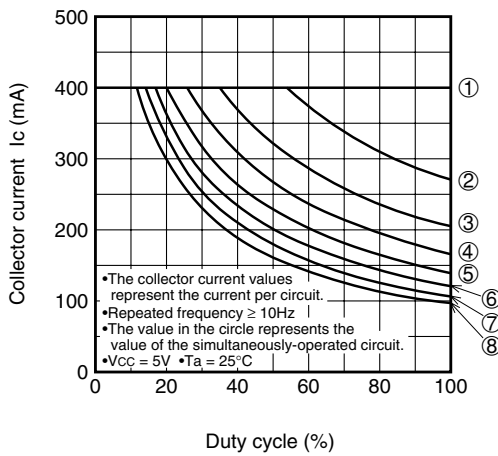

Duty-Cycle-Collector Characteristics (M54583FP)

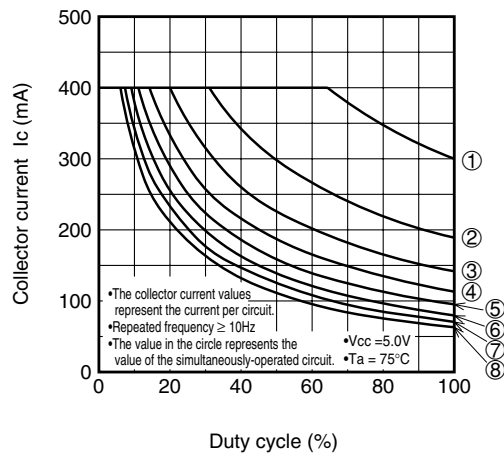

**M54583P/FP**

8-UNIT 400mA DARLINGTON TRANSISTOR ARRAY

**Input Characteristics**

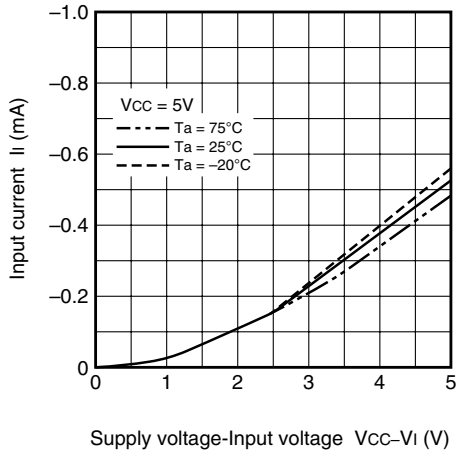

**DC Amplification Factor  
Collector Current Characteristics**

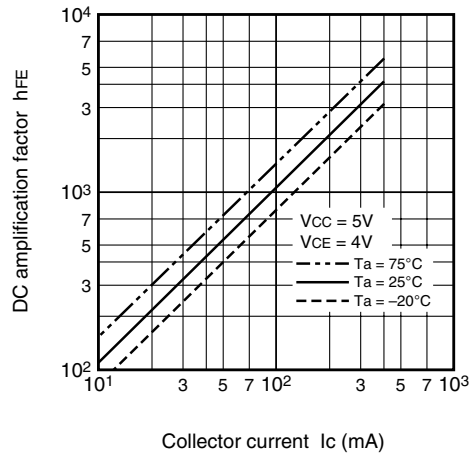

**Grounded Emitter Transfer Characteristics**

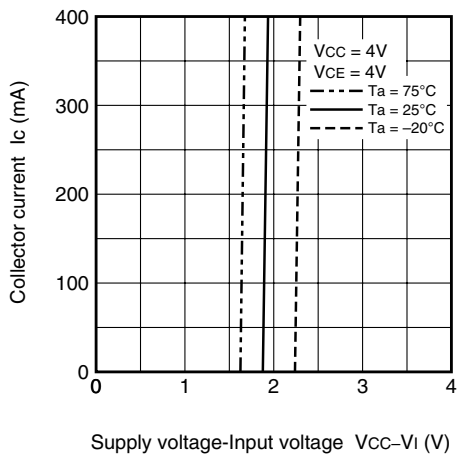

**Supply Current Characteristics**

