

M54583P/FP

8-UNIT 400mA DARLINGTON TRANSISTOR ARRAY

DESCRIPTION

M54583P and M54583FP are eight-circuit collector-current-synchronized Darlington transistor arrays. The circuits are made of PNP and NPN transistors. Both the semiconductor integrated circuits perform high-current driving with extremely low input-current supply.

FEATURES

- High breakdown voltage ($BV_{CEO} \geq 50V$)
- High-current driving ($I_{c(max)} = 400mA$)
- Active L-level input
- With input clamping diodes

APPLICATION

Interfaces between microcomputers and high-voltage, high-current drive systems, drives of relays and printers, and MOS-bipolar logic IC interfaces

FUNCTION

The M54583 is produced by adding PNP transistors to M54523 inputs. Eight circuits having active L-level inputs are provided.

Resistance of $7k\Omega$ and diode are provided in series between each input and PNP transistor base. The input diode is intended to prevent the flow of current from the input to the V_{cc} . Without this diode, the current flow from "H" input to the V_{cc} and the "L" input circuits is activated, in such case where one of the inputs of the 8 circuits is "H" and the others are "L" to save power consumption. The diode is inserted to prevent such misoperation.

This device is most suitable for a driver using NMOS IC output especially for the driver of current sink.

Collector current is 400mA maximum. Collector-emitter supply voltage is 50V.

The 54583FP is enclosed in a molded small flat package, enabling space saving design.

PIN CONFIGURATION (TOP VIEW)

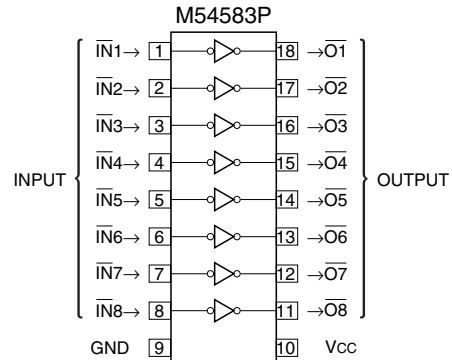

Outline 18P4G

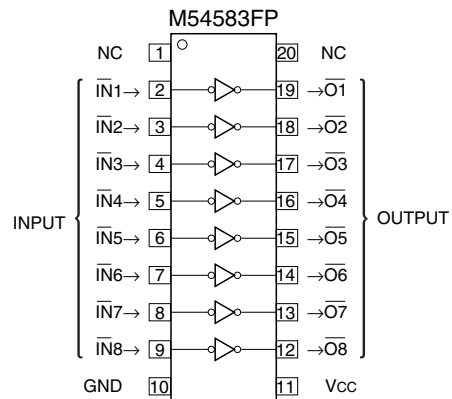

Outline 20P2N-A

NC : No connection

CIRCUIT DIAGRAM (EACH CIRCUIT)

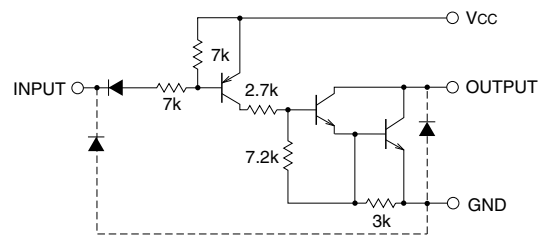

The eight circuits share the V_{cc} and GND.

The diode, indicated with the dotted line, is parasitic, and cannot be used.

Unit : Ω

M54583P/FP

8-UNIT 400mA DARLINGTON TRANSISTOR ARRAY

ABSOLUTE MAXIMUM RATINGS (Unless otherwise noted, Ta = -20 ~ +75°C)

Symbol	Parameter	Conditions	Ratings	Unit
V _{CC}	Supply voltage		10	V
V _{CEO}	Collector-emitter voltage	Output, H	-0.5 ~ +50	V
V _I	Input voltage		-0.5 ~ V _{CC}	V
I _C	Collector current	Current per circuit output, L	400	mA
P _d	Power dissipation	Ta = 25°C, when mounted on board	1.79/1.1	W
T _{opr}	Operating temperature		-20 ~ +75	°C
T _{stg}	Storage temperature		-55 ~ +125	°C

RECOMMENDED OPERATING CONDITIONS (Unless otherwise noted, Ta = -20 ~ +75°C)

Symbol	Parameter	Limits			Unit	
		min	typ	max		
V _{CC}	Supply voltage	4	5	8	V	
I _C	Collector current Per channel	V _{CC} = 5V, Duty Cycle P : no more than 10% FP : no more than 5%	0	—	350	mA
		V _{CC} = 5V, Duty Cycle P : no more than 34% FP : no more than 15%	0	—	200	
V _{IH}	"H" input voltage	V _{CC} -0.7	—	V _{CC}	V	
V _{IL}	"L" input voltage	0	—	V _{CC} -3.6	V	

ELECTRICAL CHARACTERISTICS (Unless otherwise noted, Ta = -20 ~ +75°C)

Symbol	Parameter	Test conditions	Limits			Unit	
			min	typ*	max		
V _{(BR)CEO}	Collector-emitter breakdown voltage	I _{CEO} = 100μA, V _{CC} = 8V	50	—	—	V	
V _{CE(sat)}	Collector-emitter saturation voltage	V _I = V _{CC} -3.6V	I _C = 350mA	—	1.2	2.2	V
			I _C = 200mA	—	0.98	1.6	
I _I	Input current	V _I = V _{CC} -3.6V	—	-320	-600	μA	
I _{CC}	Supply current (one circuit coming on)	V _{CC} = 5V, V _I = V _{CC} -3.6V	—	1.9	3	mA	
h _{FE}	DC amplification factor	V _{CE} = 4V, V _{CC} = 5V, I _C = 350mA, Ta = 25°C	2000	3500	—	—	

* : The typical values are those measured under ambient temperature (Ta) of 25°C. There is no guarantee that these values are obtained under any conditions.

SWITCHING CHARACTERISTICS (Unless otherwise noted, Ta = 25°C)

Symbol	Parameter	Test conditions	Limits			Unit
			min	typ	max	
t _{on}	Turn-on time	C _L = 15pF (note 1)	—	130	—	ns
t _{off}	Turn-off time		—	3200	—	ns

NOTE 1 TEST CIRCUIT

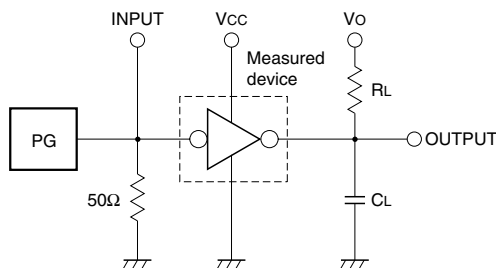

- (1) Pulse generator (PG) characteristics : PRR = 1kHz, t_w = 10μs, t_r = 6ns, t_f = 6ns, Z₀ = 50Ω, V_I = 0.4 to 4V
- (2) Input-output conditions : R_L = 30Ω, V_O = 10V, V_{CC} = 4V
- (3) Electrostatic capacity C_L includes floating capacitance at connections and input capacitance at probes

TIMING DIAGRAM

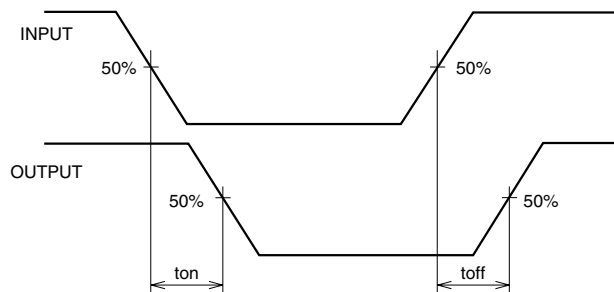

M54583P/FP

8-UNIT 400mA DARLINGTON TRANSISTOR ARRAY

TYPICAL CHARACTERISTICS

Thermal Derating Factor Characteristics

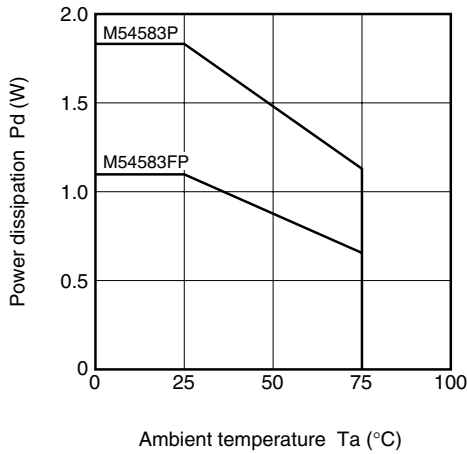

Output Saturation Voltage Collector Current Characteristics

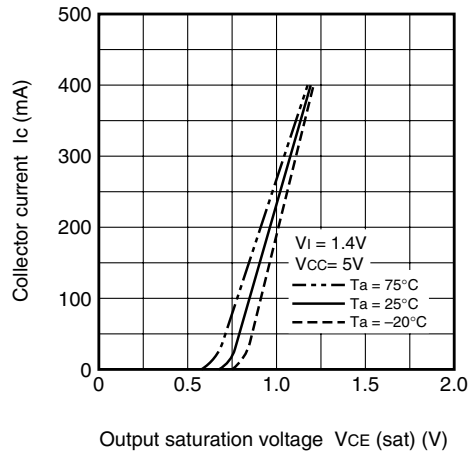

Duty-Cycle-Collector Characteristics (M54583P)

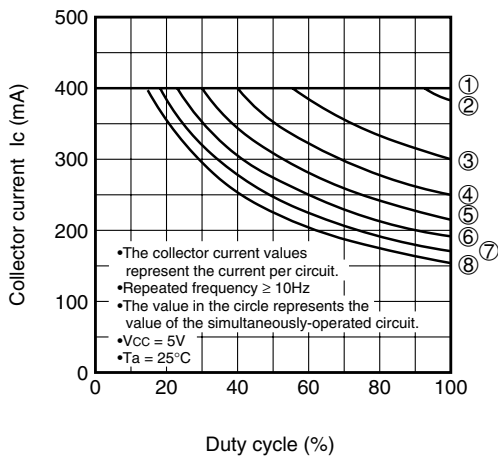

Duty-Cycle-Collector Characteristics (M54583P)

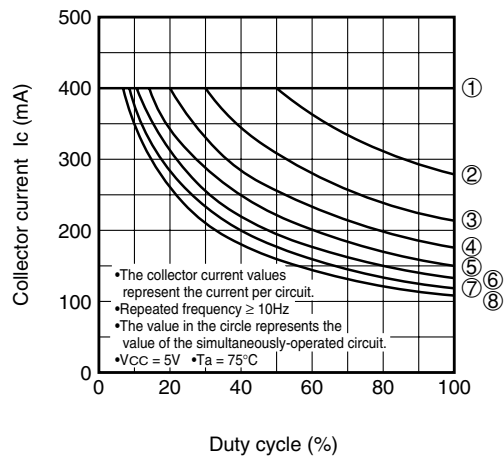

Duty-Cycle-Collector Characteristics (M54583FP)

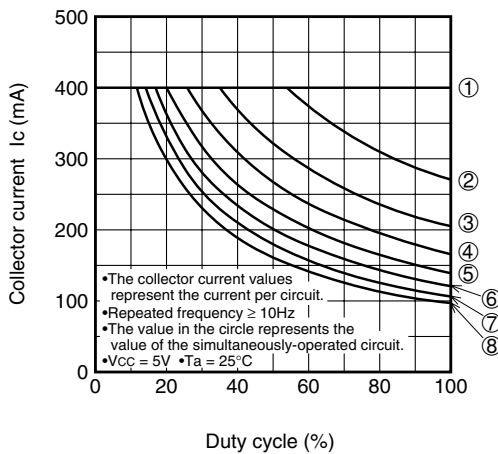

Duty-Cycle-Collector Characteristics (M54583FP)

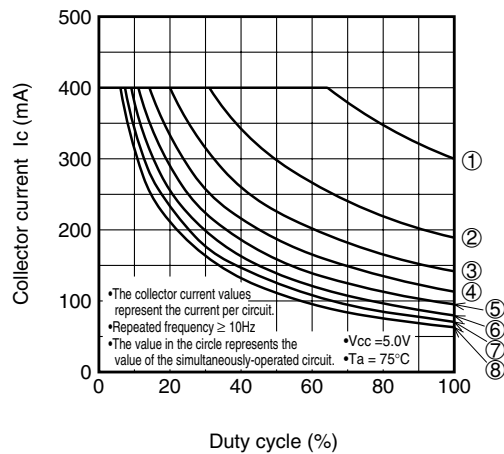

M54583P/FP

8-UNIT 400mA DARLINGTON TRANSISTOR ARRAY

Input Characteristics

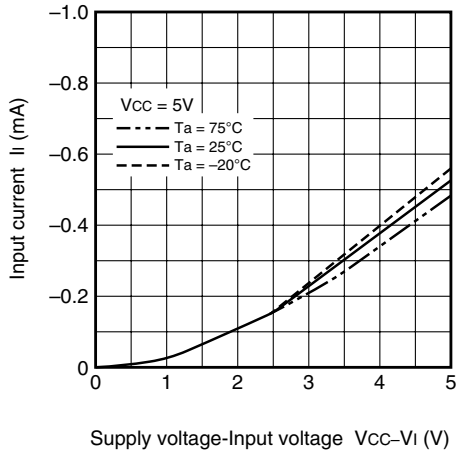

DC Amplification Factor
Collector Current Characteristics

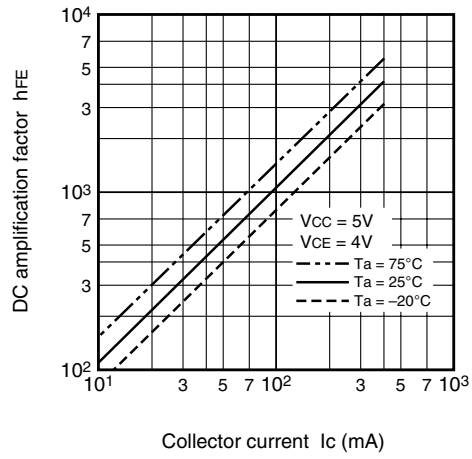

Grounded Emitter Transfer Characteristics

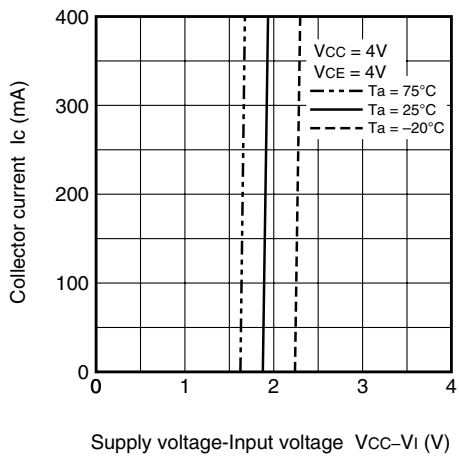

Supply Current Characteristics

