

POW-R-BLOK™ Dual SCR/Diode Isolated Module 500 Amperes / Up to 1600 Volts

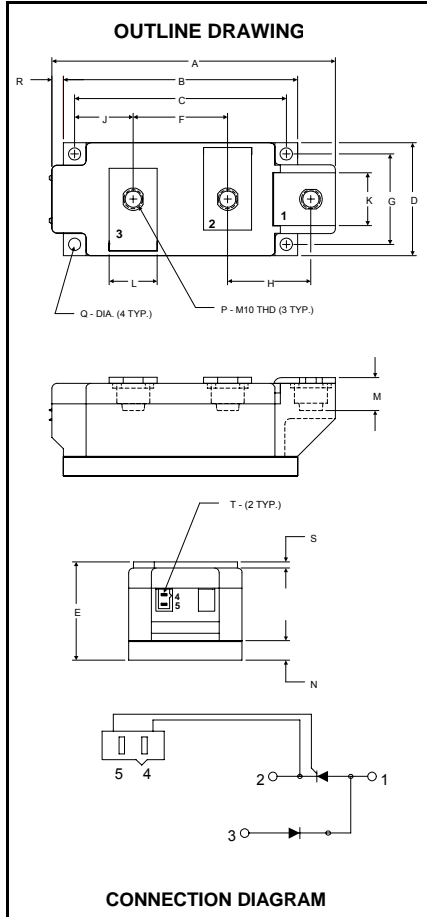

LD42__50 Dual SCR/Diode POW-R-BLOK™ Module 500 Amperes / 800-1600 Volts

LD42 Outline Dimensions

| Dimension | Inches | Millimeters |
|-----------|-------------|-------------|
| A | 5.91 | 150.0 |
| B | 4.88 | 124.0 |
| C | 4.41 | 112.0 |
| D | 2.36 | 60.0 |
| E | 2.05 | 52.0 |
| F | 1.97 | 50.0 |
| G | 1.89 | 48.0 |
| H | 1.73 | 44.0 |
| J | 1.22 | 31.0 |
| K | 1.10 | 28.0 |
| L | 1.00 | 25.4 |
| M | 0.69 | 17.5 |
| N | 0.39 | 10.0 |
| P | M10 Metric | M10 |
| Q | 0.26 Dia. | 6.5 Dia. |
| R | 0.24 | 6.0 |
| S | 0.12 | 3.0 |
| T | .110 x .032 | 2.5 x 0.8 |

Note: Dimensions are for reference only.

Ordering Information:

Select the complete eight-digit module part number from the table below.

Example: LD421650 is a 1600Volt, 500 Ampere Dual SCR/Diode Isolated POW-R-BLOK™ Module.

| Type | Voltage Volts (x100) | Current Amperes (x10) |
|------|----------------------------|-----------------------------|
| LD42 | 08 | 50 |
| | 10 | |
| | 12 | |
| | 14 | |
| | 16 | |

Description:

Powerex Dual SCR/Diode Modules are designed for use in applications requiring phase control and isolated packaging. The modules are isolated for easy mounting with other components on a common heatsink. POW-R-BLOK™ has been tested and recognized by the Underwriters Laboratories.

Features:

- Electrically Isolated Heatsinking
- Aluminum Nitride Isolator
- Compression Bonded Elements
- Metal Baseplate
- Low Thermal Impedance for Improved Current Capability
- UL Recognized

Benefits:

- No Additional Insulation Components Required
- Easy Installation
- No Clamping Components Required
- Reduce Engineering Time

Applications:

- Bridge Circuits
- AC & DC Motor Drives
- Battery Supplies
- Power Supplies
- Large IGBT Circuit Front Ends

Absolute Maximum Ratings

| Characteristics | Conditions | Symbol | Units |
|---|---|-------------------------|---------------------------------------|
| Repetitive Peak Forward and Reverse Blocking Voltage | | V_{DRM} & V_{RRM} | up to 1600 V |
| Non-Repetitive Peak Blocking Voltage ($t < 5$ msec) | | V_{RSM} | $V_{RRM} + 100$ V |
| RMS Forward Current | 180° Conduction, $T_C=86^\circ\text{C}$ | $I_{T(RMS)}/I_{F(RMS)}$ | 785 A |
| Average Forward Current | 180° Conduction, $T_C=86^\circ\text{C}$ | $I_{T(AV)}/I_{F(AV)}$ | 500 A |
| Peak One Cycle Surge Current, Non-Repetitive | 60 Hz, 100% V_{RRM} reapplied | I_{TSM}/I_{FSM} | 17,000 A |
| | 50 Hz, 100% V_{RRM} reapplied | I_{TSM}/I_{FSM} | 16,300 A |
| Peak Three Cycle Surge Current, Non-Repetitive | 60 Hz, 100% V_{RRM} reapplied | I_{TSM}/I_{FSM} | 12,250 A |
| Peak Ten Cycle Surge Current, Non-Repetitive | 60 Hz, 100% V_{RRM} reapplied | I_{TSM}/I_{FSM} | 10,500 A |
| I^2t for Fusing for One Cycle | 8.3 milliseconds | I^2t | 1.20×10^6 A ² sec |
| | 10 milliseconds | I^2t | 1.33×10^6 A ² sec |
| Maximum Rate-of-Rise of On-State Current, (Repetitive) | Per JEDEC Standard 397 5.2.2.6 | di/dt | 200 A/ μ s |
| Operating Temperature | | T_J | -40 to +130 °C |
| Storage Temperature | | T_{stg} | -40 to +150 °C |
| Max. Mounting Torque, M6 Mounting Screw | | | 55 in. – Lb. |
| | | | 6 Nm |
| Max. Mounting Torque, M10 Terminal Screw | | | 110 in. – Lb. |
| | | | 12 Nm |
| Module Weight, Typical | | | 1500 g |
| | | | 3.30 lb |
| V Isolation @ 25C | | V_{rms} | 3000 V |

Electrical Characteristics, T_J=25°C unless otherwise specified

| Characteristics | Symbol | Test Conditions | Min. | Max. | Units |
|--|----------------------------------|--|-----------|-----------|-------|
| Repetitive Peak Forward Leakage Current | I _{DRM} | Up to 1600V, T _J =130°C | | 80 | mA |
| Repetitive Peak Reverse Leakage Current | I _{RRM} | Up to 1600V, T _J =130°C | | 80 | mA |
| Peak On-State Voltage | V _{TM} /V _{FM} | I _{TM} /I _{FM} =1500A | | 1.30 | V |
| Threshold Voltage, Low-level | V _{(TO)1} | T _J = 130°C, I = 15%I _{T(AV)} to πI _{T(AV)} | | 0.81 | V |
| Slope Resistance, Low-level | r _{T1} | | | 0.32 | mΩ |
| Threshold Voltage, High-level | V _{(TO)2} | T _J = 130°C, I = πI _{T(AV)} to I _{TSM} | | 0.90 | V |
| Slope Resistance, High-level | r _{T2} | | | 0.26 | mΩ |
| V _{TM} Coefficients, Full Range | | T _J = 130°C, I = 10A to 6kA | A = | 0.8824 | |
| | | | B = | -4.46E-02 | |
| | | V _{TM} /V _{FM} = A+ B Ln I + C I + D Sqrt I | C = | 8.12E-05 | |
| | | | D = | 1.54E-02 | |
| Minimum dV/dt | dV/dt | Exponential to V _{DRM} T _J =130°C, Gate Open | 1000 Typ. | | V/μs |
| Gate Trigger Current | I _{GT} | T _J =25°C, V _D =12V | | 200 | mA |
| Gate Trigger Voltage | V _{GT} | T _J =25°C, V _D =12V | | 3.0 | Volts |
| Non-Triggering Gate Voltage | V _{GDM} | T _J =130°C, V _D = ½ V _{DRM} | | 0.25 | Volts |
| Peak Forward Gate Current | I _{GTM} | | | 4.0 | Amp |
| Peak Reverse Gate Voltage | V _{GRM} | | | 5 | Volts |

Thermal Characteristics

| Characteristics | Symbol | | Max. | Units |
|---|-------------------|--|--|--|
| Thermal Resistance, Junction to Case | R _{ΘJ-C} | Per Module, both conducting Per Junction, both conducting | 0.0325 0.0650 | °C/W °C/W |
| Thermal Impedance Coefficients | Z _{ΘJ-C} | Z _{ΘJ-C} = K ₁ (1-exp(-t/τ ₁)) + K ₂ (1-exp(-t/τ ₂)) + K ₃ (1-exp(-t/τ ₃)) + K ₄ (1-exp(-t/τ ₄)) | K ₁ = 8.03E-04 K ₂ = 1.03E-02 K ₃ = 1.64E-02 K ₄ = 3.75E-02 | τ ₁ = 3.39E-04 τ ₂ = 3.15E-03 τ ₃ = 0.106 τ ₄ = 2.066 |
| Thermal Resistance, Case to Sink Lubricated | R _{ΘC-S} | Per Module | 0.01 | °C/W |

Maximum On-State Forward Voltage Drop
 (T_j = 130 °C)

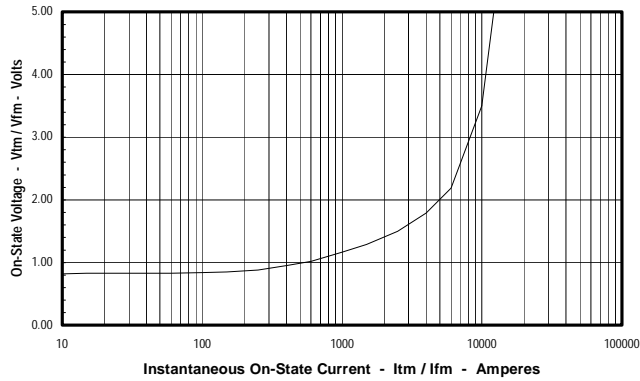

Maximum Transient Thermal Impedance
 (Junction to Case, Per Junction)

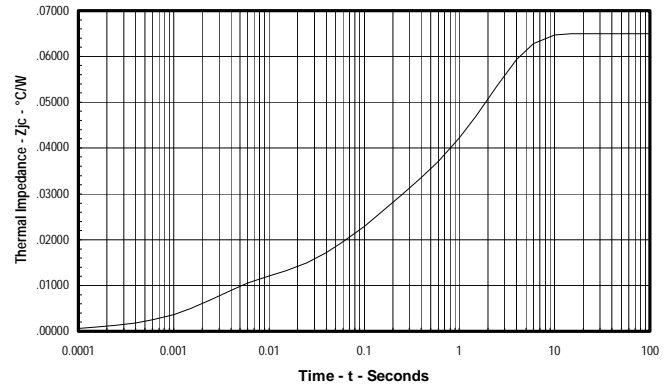

Maximum On-State Power Dissipation
 (Sinusoidal Waveform)

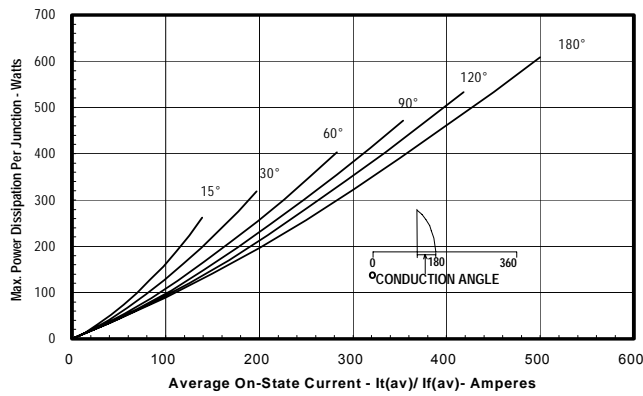

Maximum Allowable Case Temperature
 (Sinusoidal Waveform)

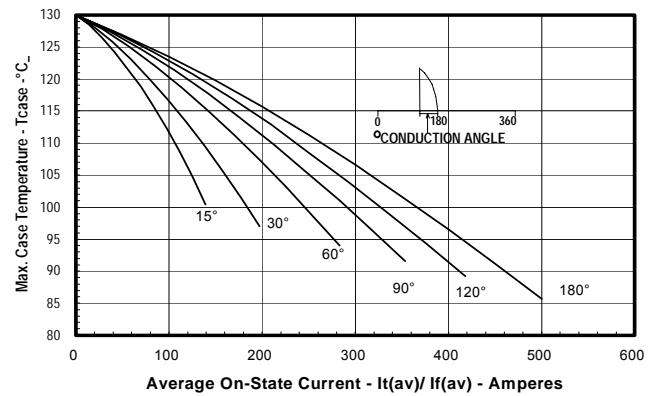

Maximum On-State Power Dissipation
 (Rectangular Waveform)

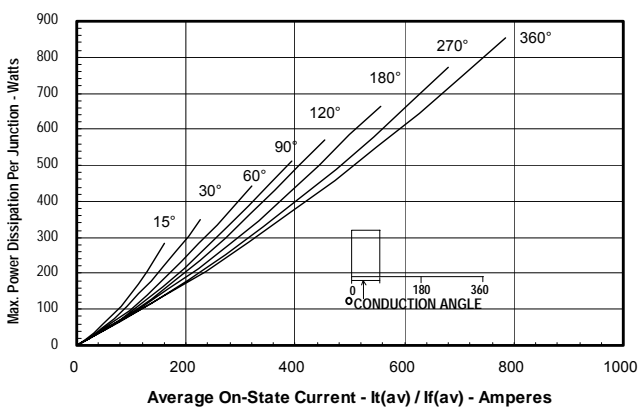

Maximum Allowable Case Temperature
 (Rectangular Waveform)

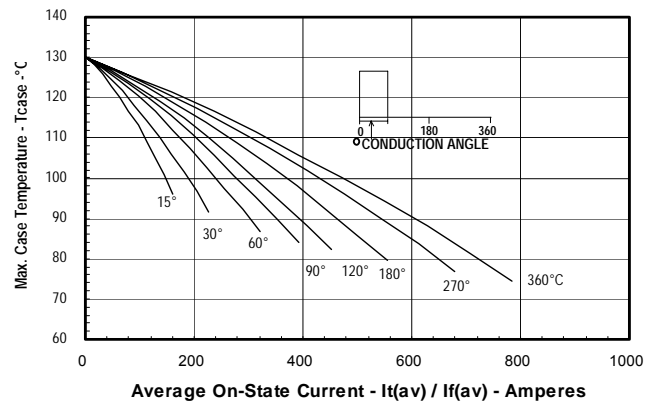

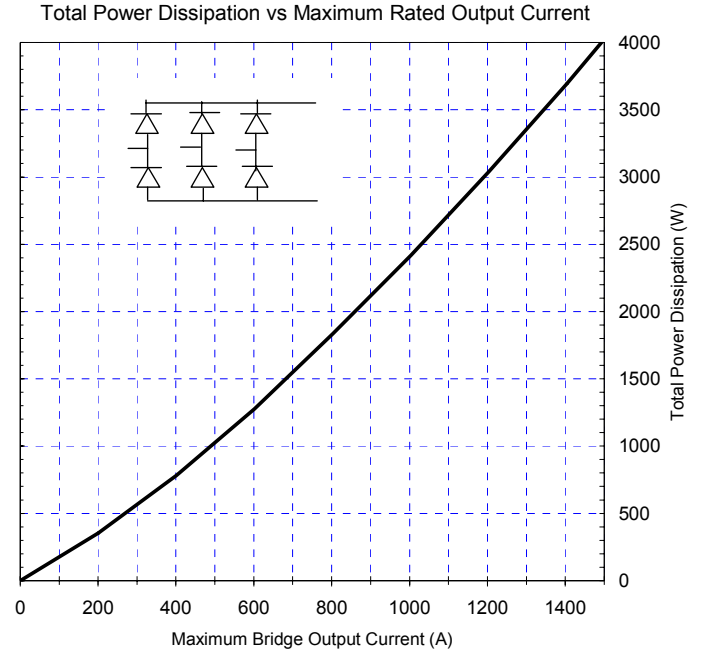
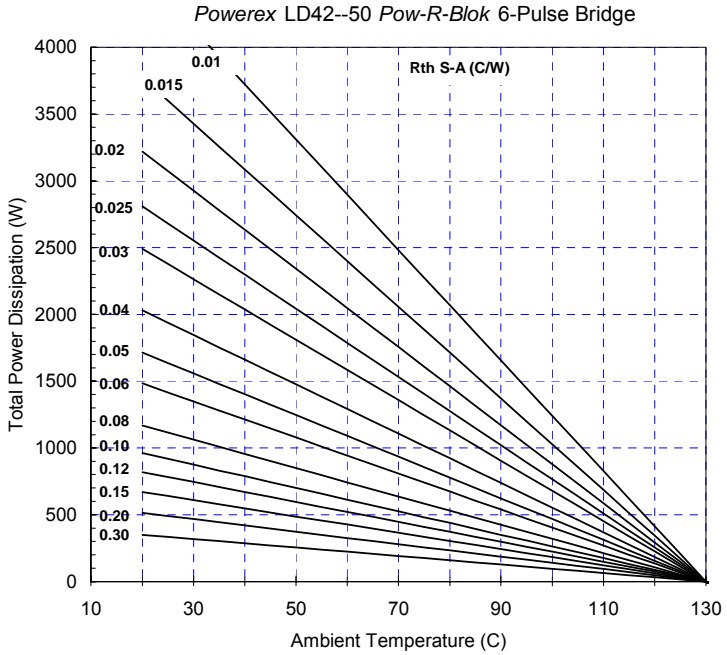

Six-Pulse Bridge Circuit Total Power Dissipation & Maximum Rated Output Current With Sink to Ambient Resistance of Heatsink as a Parameter.