

mitsubishi
MITSUBISHI INSULATED GATE BIPOLAR TRANSISTOR

CT75AM-12

GENERAL INVERTER • UPS USE

CT75AM-12

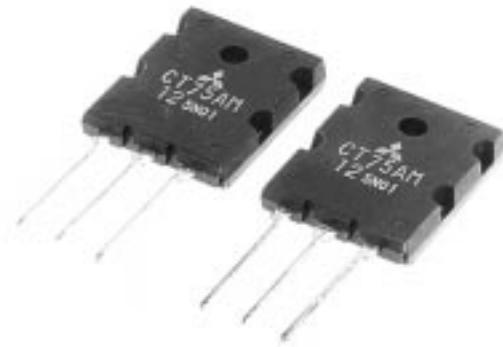

- VCES 600V
- IC 75A
- High Speed Switching
- Low VCE Saturation Voltage

OUTLINE DRAWING

Dimensions in mm

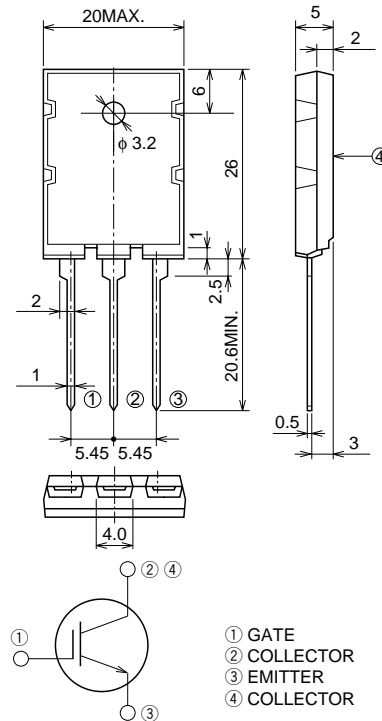

TO-3PL

APPLICATION

AC & DC motor controls, General purpose inverters, UPS, Power supply switching, Servo controls, etc.

MAXIMUM RATINGS (Tc = 25°C)

Symbol	Parameter	Conditions	Ratings	Unit
V _{CE} S	Collector-emitter voltage	V _{GE} = 0V	600	V
V _{GES}	Gate-emitter voltage	V _{CE} = 0V	±20	V
V _{GEM}	Peak gate-emitter voltage	V _{CE} = 0V	±30	V
I _C	Collector current		75	A
I _{CM}	Collector current (Pulsed)		150	A
P _C	Maximum power dissipation		300	W
T _j	Junction temperature		-40 ~ +150	°C
T _{stg}	Storage temperature		-40 ~ +150	°C
—	Weight	Typical value	9.8	g

ELECTRICAL CHARACTERISTICS ($T_j = 25^\circ\text{C}$)

Symbol	Parameter	Test conditions	Limits			Unit
			Min.	Typ.	Max.	
V (BR) CES	Collector-emitter breakdown voltage	$I_C = 1\text{mA}, V_{GE} = 0\text{V}$	600	—	—	V
I _{GES}	Collector-emitter leakage current	$V_{GE} = \pm 30\text{V}, V_{CE} = 0\text{V}$	—	—	± 0.5	μA
I _{CES}	Gate-emitter leakage current	$V_{CE} = 600\text{V}, V_{GE} = 0\text{V}$	—	—	1	mA
V _{GE(th)}	Gate-emitter threshold voltage	$I_C = 7.5\text{mA}, V_{CE} = 10\text{V}$	4.5	6.0	7.5	V
V _{CE(sat)}	Collector-emitter saturation voltage	$I_C = 75\text{A}, V_{GE} = 15\text{V}$	—	2.5	3.0	V
C _{ies}	Input capacitance	$V_{CE} = 25\text{V}, V_{GE} = 0\text{V}, f = 1\text{MHz}$	—	3100	—	pF
C _{oes}	Output capacitance		—	400	—	pF
C _{res}	Reverse transfer capacitance		—	130	—	pF
t _{d (on)}	Turn-on delay time	$V_{CC} = 300\text{V}, \text{Resistance load}, I_C = 75\text{A}, V_{GE} = 15\text{V}, R_{GE} = 10\Omega$	—	40	—	ns
t _r	Rise time		—	265	—	ns
t _{d (off)}	Turn-off delay time		—	175	—	ns
t _f	Fall time		—	245	—	ns
R _{th (j-c)}	Thermal resistance	Junction to case	—	—	0.42	$^\circ\text{C/W}$

PERFORMANCE CURVES

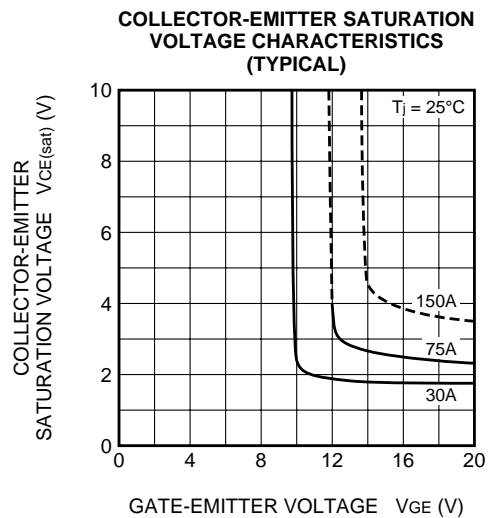
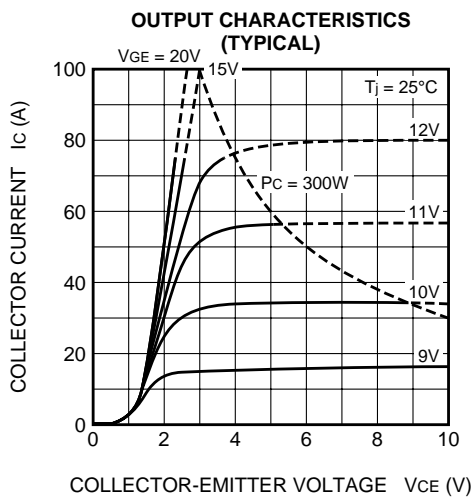

COLLECTOR-EMITTER SATURATION VOLTAGE CHARACTERISTICS (TYPICAL)

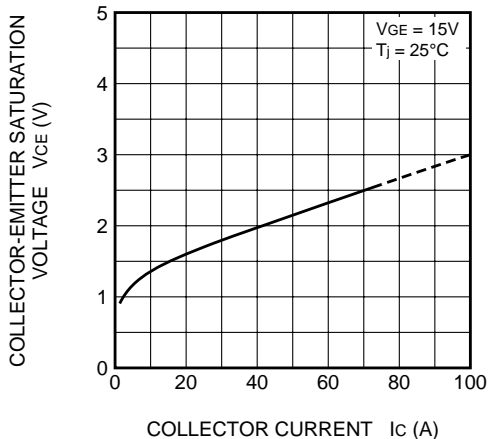

COLLECTOR CURRENT VS. GATE EMITTER VOLTAGE CHARACTERISTIC (TYPICAL)

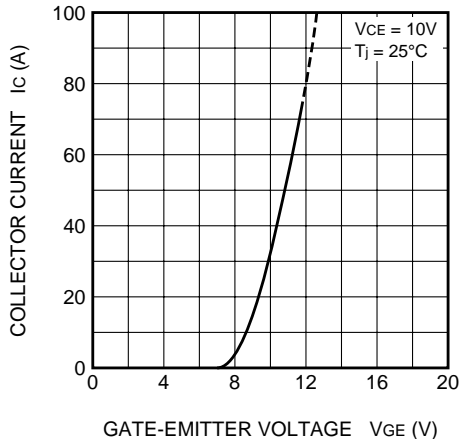

CAPACITANCE VS. COLLECTOR-EMITTER VOLTAGE CHARACTERISTIC (TYPICAL)

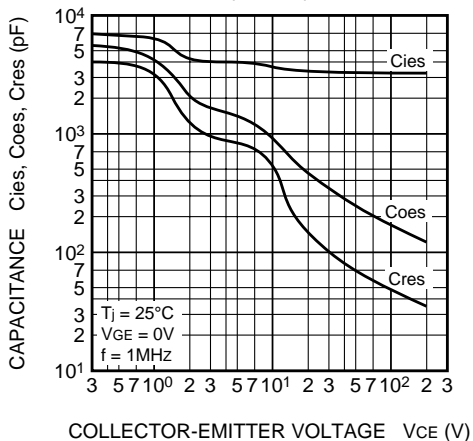

SWITCHING TIME-COLLECTOR CURRENT CHARACTERISTIC (TYPICAL)

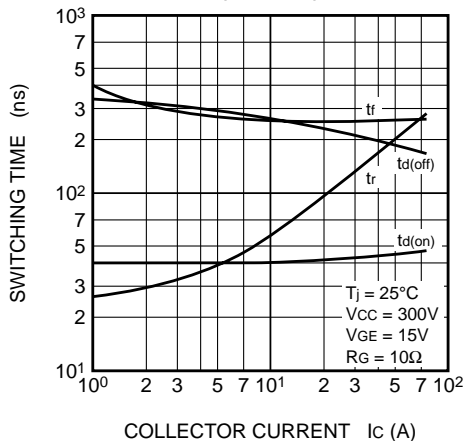

GATE-EMITTER VOLTAGE VS. GATE CHARGE CHARACTERISTIC (TYPICAL)

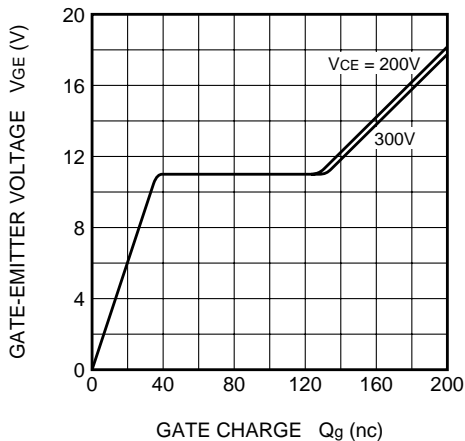

TRANSIENT THERMAL IMPEDANCE CHARACTERISTICS (TYPICAL)

