

### Split SCR/Diode POW-R-BLOK™ Modules 20 Amperes/800 Volts

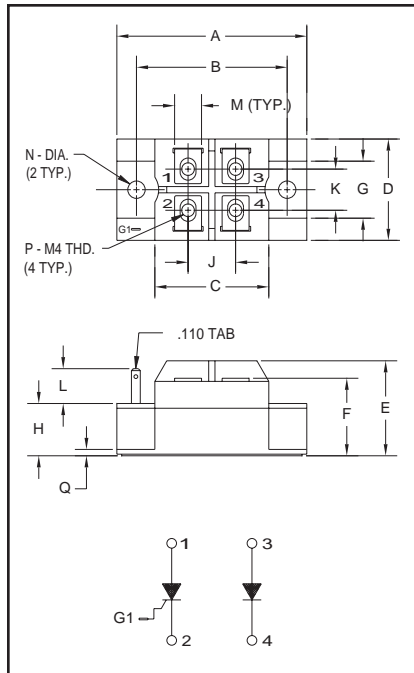

Outline Drawing

Dimension	Inches	Millimeters
A	2.362 Max.	60 Max.
B	1.874	47.6
C	1.417	36
D	1.260 Max.	32 Max.
E	1.181 Max.	30 Max.
F	0.964	24.5
G	0.709	18
H	0.650	16.5
J	0.591	15
K	0.512	13
L	0.433	11
M	0.335	8.5
N	0.216 Dia.	Dia. 5.5
P	M4 Metric	M4
Q	0.079	2



CT220802  
Split SCR/Diode  
POW-R-BLOK™ Modules  
20 Amperes/800 Volts

#### Description:

Powerex Split SCR/Diode POW-R-BLOK™ Modules are designed for use in applications requiring control and rectification. The modules are isolated for easy mounting with other components on common heatsinks.

#### Features:

- Isolated Mounting
- Glass Passivated Chips
- Metal Baseplate
- Low Thermal Impedance
- Four Terminal Flexibility

#### Applications:

- Battery Supplies
- Contactless Switches
- Furnace Control
- Light Dimmers

#### Ordering Information:

Select the complete eight digit module part number you desire from the table below.

Example: CT220802 is an 800 Volt, 20 Ampere Split SCR/Diode POW-R-BLOK™ Module.

Type	Voltage Volts (x100)	Current Rating Amperes (x10)
CT22	08	02



Powerex, Inc., 200 Hillis Street, Youngwood, Pennsylvania 15697-1800 (724) 925-7272

**CT220802**

**Split SCR/Diode POW-R-BLOK™ Modules**

20 Amperes/800 Volts

**Absolute Maximum Ratings**

Characteristics	Symbol	CT220802	Units
Peak Forward Blocking Voltage	$V_{DRM}$	800	Volts
Transient Peak Forward Blocking Voltage (Non-Repetitive), $t < 5ms$	$V_{DSM}$	960	Volts
DC Forward Blocking Voltage	$V_{D(DC)}$	640	Volts
Peak Reverse Blocking Voltage	$V_{RRM}$	800	Volts
Transient Peak Reverse Blocking Voltage (Non-Repetitive), $t < 5ms$	$V_{RSM}$	960	Volts
DC Reverse Blocking Voltage	$V_{R(DC)}$	640	Volts
RMS On-State Current	$I_{T(RSM)}, I_{F(RSM)}$	30	Amperes
Average On-State Current, $T_C = 87^\circ C$	$I_{T(AV)}, I_{F(AV)}$	20	Amperes
Peak One-Cycle Surge (Non-Repetitive) On-State Current (60Hz)	$I_{TSM}, I_{FSM}$	400	Amperes
Peak One-Cycle Surge (Non-Repetitive) On-State Current (50Hz)	$I_{TSM}, I_{FSM}$	365	Amperes
$I^2t$ (for Fusing), 8.3 milliseconds	$I^2t$	667	$A^2sec$
Critical Rate-of-Rise of On-State Current*	$di/dt$	100	Amperes/ $\mu s$
Peak Gate Power Dissipation	$P_{GM}$	5.0	Watts
Average Gate Power Dissipation	$P_{G(AV)}$	0.5	Watts
Peak Forward Gate Voltage	$V_{GFM}$	10	Volts
Peak Reverse Gate Voltage	$V_{GRM}$	5.0	Volts
Peak Forward Gate Current	$I_{GFM}$	2.0	Amperes
Storage Temperature	$T_{STG}$	-40 to 125	$^\circ C$
Operating Temperature	$T_j$	-40 to 125	$^\circ C$
Maximum Mounting Torque M5 Mounting Screw	—	17	in.-lb.
Maximum Mounting Torque M4 Terminal Screw	—	12	in.-lb.
Module Weight (Typical)	—	80	Grams
V Isolation	$V_{RMS}$	2000	Volts

\* $T_j = 125^\circ C, I_G = 0.5A, V_D = 1/2 V_{DRM}$

**Electrical and Thermal Characteristics,  $T_j = 25^\circ C$  unless otherwise specified**

Characteristics	Symbol	Test Conditions	CT220802	Units
<b>Blocking State Maximums</b>				
Forward Leakage Current, Peak	$I_{DRM}$	$T_j = 125^\circ C, V_{DRM} = \text{Rated}$	4.0	mA
Reverse Leakage Current, Peak	$I_{RRM}$	$T_j = 125^\circ C, V_{RRM} = \text{Rated}$	4.0	mA
<b>Conducting State Maximums</b>				
Peak On-State Voltage	$V_{FM}, V_{TM}$	$I_{FM} = 60A, I_{TM} = 60A$	1.8	Volts
<b>Switching Minimums</b>				
Critical Rate-of-Rise of Off-State Voltage	$dv/dt$	$T_j = 125^\circ C, V_D = 2/3 V_{DRM}$	500	Volts/ $\mu s$
<b>Thermal Maximums</b>				
Thermal Resistance, Junction-to-Case	$R_{\theta(J-C)}$	Per Module	1.0	$^\circ C/Watt$
Thermal Resistance, Case-to-Sink (Lubricated)	$R_{\theta(C-S)}$	Per Module	0.25	$^\circ C/Watt$
<b>Gate Parameters Maximums</b>				
Gate Current-to-Trigger	$I_{GT}$	$V_D = 6V, R_L = 2\Omega$	50	mA
Gate Voltage-to-Trigger	$V_{GT}$	$V_D = 6V, R_L = 2\Omega$	3.0	Volts
Non-Triggering Gate Voltage	$V_{GDM}$	$T_j = 125^\circ C, V_D = 1/2 V_{DRM}$	0.25	Volts

**CT220802**  
**Split SCR/Diode POW-R-BLOK™ Modules**  
 20 Amperes/800 Volts

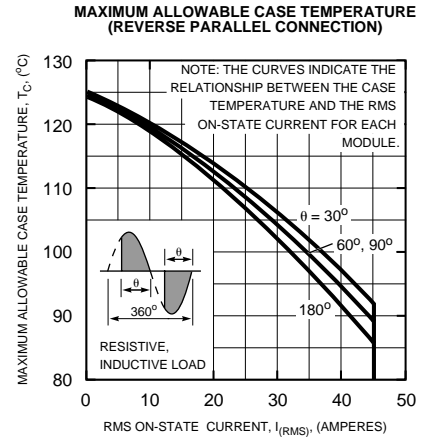
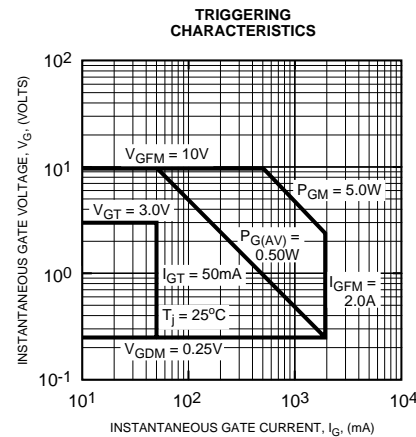
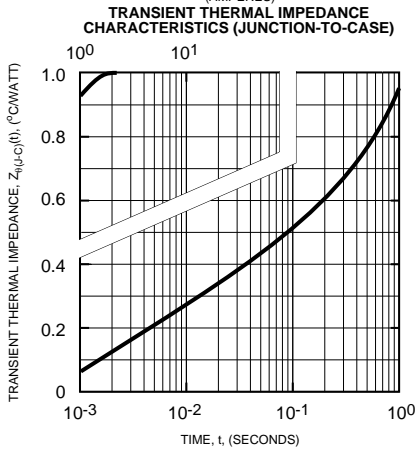
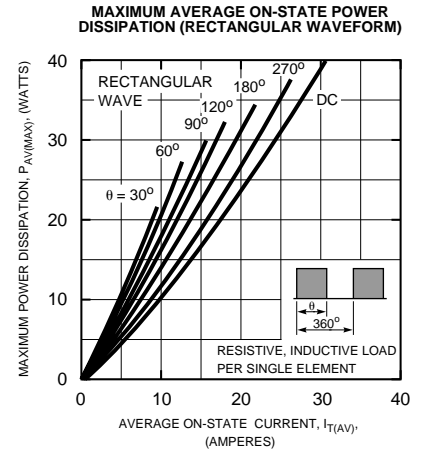
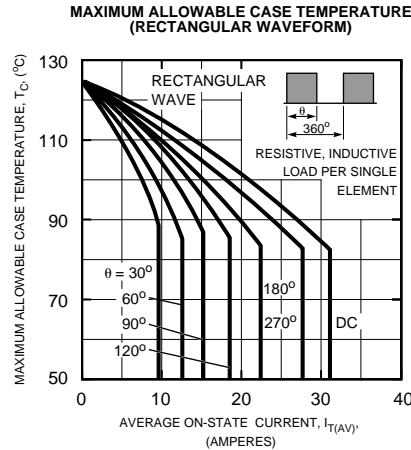
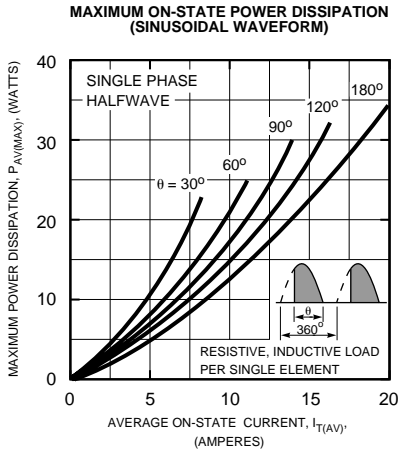
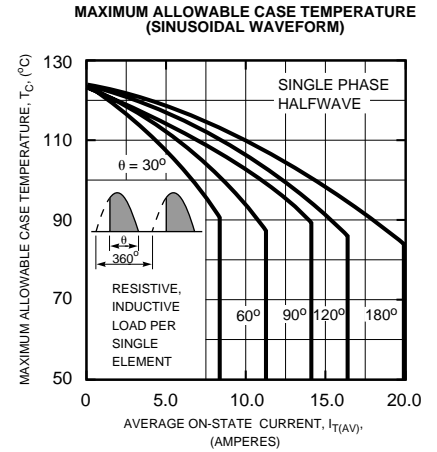
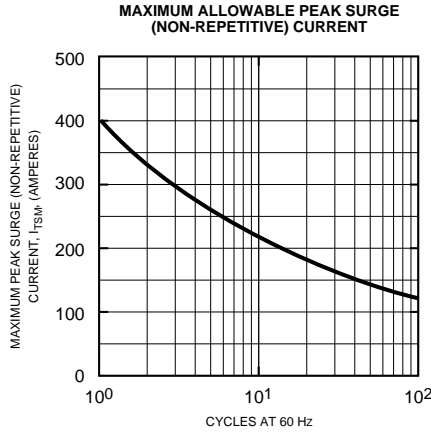
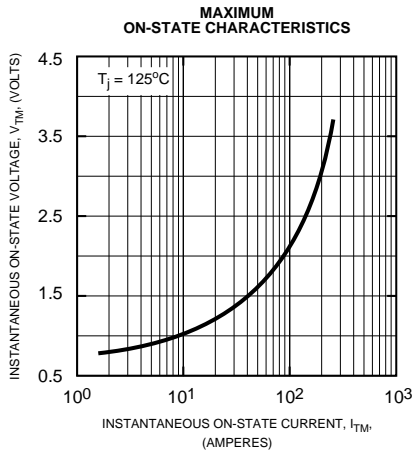

**CT220802**

**Split SCR/Diode POW-R-BLOK™ Modules**  
20 Amperes/800 Volts

**MAXIMUM ON-STATE POWER DISSIPATION  
(REVERSE PARALLEL CONNECTION)**

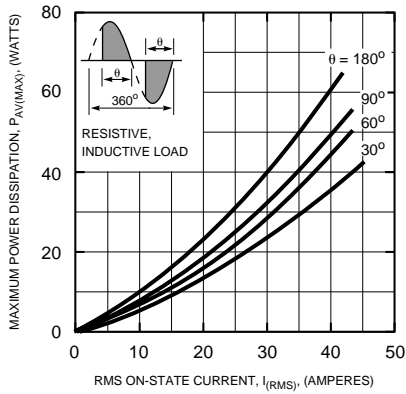

**MAXIMUM ALLOWABLE CASE TEMPERATURE  
(SINGLE PHASE BRIDGE CONNECTION)**

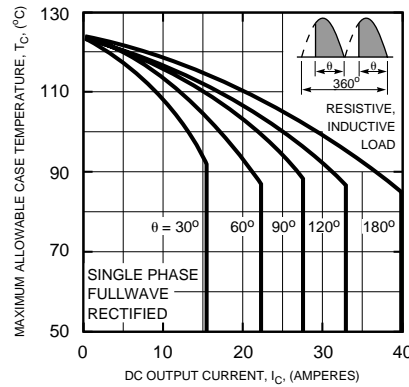

**MAXIMUM ON-STATE POWER DISSIPATION  
(SINGLE PHASE BRIDGE CONNECTION)**

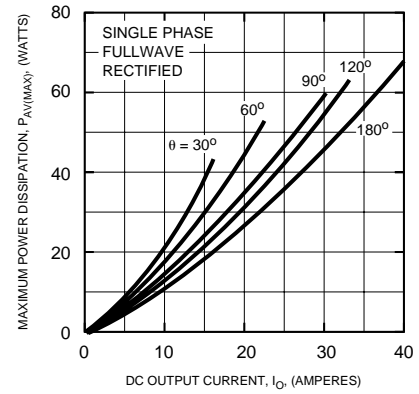

**MAXIMUM ALLOWABLE CASE TEMPERATURE  
(THREE PHASE BRIDGE CONNECTION)**

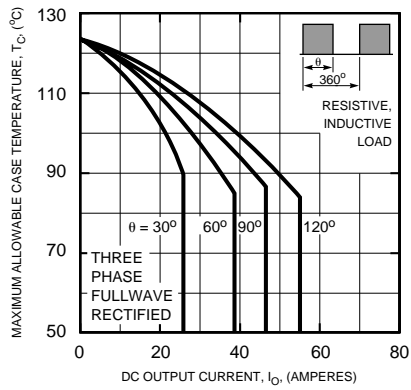

**MAXIMUM ON-STATE POWER DISSIPATION  
(THREE PHASE BRIDGE CONNECTION)**

