

NX-Series CIB Module (3Ø Converter + 3Ø Inverter + Brake) 75 Amperes/600 Volts

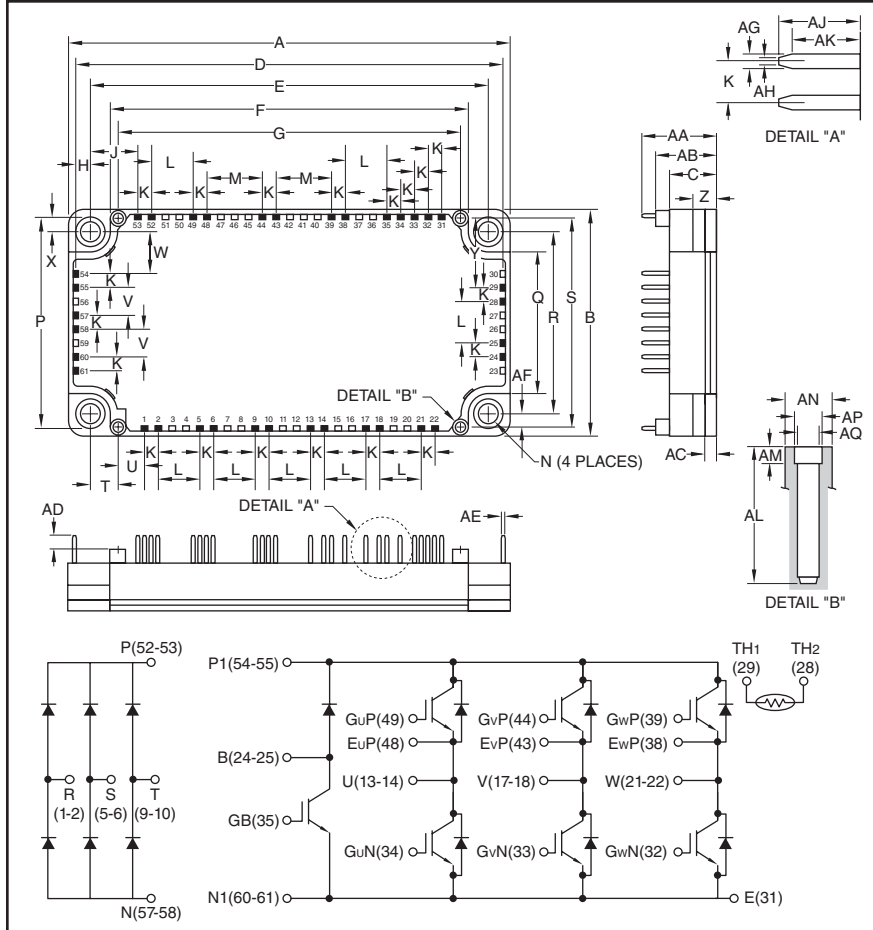

Outline Drawing and Circuit Diagram

Dimensions	Inches	Millimeters
A	4.79	121.7
B	2.44	62.0
C	0.51	13.0
D	4.65	118.1
E	4.33±0.02	110.0±0.5
F	3.89	99.0
G	3.72	94.5
H	0.16	4.06
J	0.51	13.09
K	0.15	3.81
L	0.45	11.43
M	0.6	15.24
N	0.22 Dia.	5.5 Dia.
P	2.30	58.4
Q	1.53	39.0
R	1.97±0.02	50.0±0.5
S	2.26	57.5
T	0.30	7.75
U	0.28	7.25
V	0.3	7.62

Dimensions	Inches	Millimeters
W	0.46	11.66
X	0.16	4.2
Y	0.61	15.48
Z	0.27	7.0
AA	0.81	20.5
AB	0.67	17.0
AC	0.12	3.0
AD	0.14	3.5
AE	0.03	0.8
AF	0.15	3.75
AG	0.05	1.15
AH	0.025	0.65
AJ	0.29	7.4
AK	0.24	6.2
AL	0.49	12.5
AM	0.06	1.5
AN	0.17 Dia.	4.3 Dia.
AP	0.10 Dia.	2.5 Dia.
AQ	0.08 Dia.	2.1 Dia.

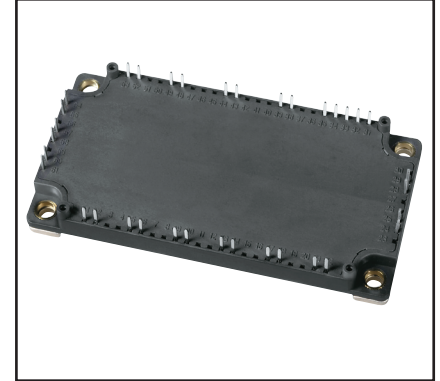

Description:

CIBs are low profile and thermally efficient. Each module consists of a three-phase diode converter section, a three-phase inverter section and a brake circuit. A thermistor is included in the package for sensing the baseplate temperature. 5th Generation CSTBT chips yield low loss.

Features:

- Low Drive Power
- Low $V_{CE(sat)}$
- Discrete Super-Fast Recovery Free-Wheel Diode
- Isolated Baseplate for Easy Heat Sinking

Applications:

- AC Motor Control
- Motion/Servo Control
- Photovoltaic/Fuel Cell

Ordering Information:

Example: Select the complete module number you desire from the table below -i.e. CM75MX-12A is a 600V (V_{CES}), 75 Ampere CIB Power Module.

Type	Current Rating Amperes	V_{CES} Volts (x 50)
CM	75	12



Powerex, Inc., 173 Pavilion Lane, Youngwood, Pennsylvania 15697 (724) 925-7272

CM75MX-12A
NX-Series CIB Module
(3Ø Converter + 3Ø Inverter + Brake)
 75 Amperes/600 Volts

Absolute Maximum Ratings, $T_j = 25^\circ\text{C}$ unless otherwise specified

Characteristics	Symbol	CM75MX-12A	Units
Power Device Junction Temperature	T_j	-40 to 150	$^\circ\text{C}$
Storage Temperature	T_{stg}	-40 to 125	$^\circ\text{C}$
Mounting Torque, M5 Mounting Screws	—	31	in-lb
Module Weight (Typical)	—	270	Grams
Isolation Voltage, AC 1 minute, 60Hz Sinusoidal	V_{ISO}	2500	Volts

Inverter Sector

Collector-Emitter Voltage (G-E Short)	V_{CES}	600	Volts
Gate-Emitter Voltage (C-E Short)	V_{GES}	± 20	Volts
Collector Current ($T_C = 70^\circ\text{C}$)*	I_C	75	Amperes
Peak Collector Current**	I_{CM}	150	Amperes
Emitter Current ($T_C = 25^\circ\text{C}$, $T_j < 150^\circ\text{C}$)*	I_E^{***}	75	Amperes
Peak Emitter Current ($T_j < 150^\circ\text{C}$ **)	I_{EM}^{***}	150	Amperes
Maximum Collector Dissipation ($T_C = 25^\circ\text{C}$, $T_j < 150^\circ\text{C}$)*	P_C	280	Watts

Brake Sector

Collector-Emitter Voltage (G-E Short)	V_{CES}	600	Volts
Gate-Emitter Voltage (C-E Short)	V_{GES}	± 20	Volts
Collector Current ($T_C = 97^\circ\text{C}$)*	I_C	50	Amperes
Peak Collector Current**	I_{CM}	100	Amperes
Maximum Collector Dissipation ($T_C = 25^\circ\text{C}$, $T_j < 150^\circ\text{C}$)*	P_C	280	Watts
Repetitive Peak Reverse Voltage (Clamp Diode Part)	V_{RRM}^{***}	600	Volts
Forward Current ($T_C = 25^\circ\text{C}$)*	I_F^{***}	50	Amperes
Forward Current (Clamp Diode Part)**	I_{FM}^{***}	100	Amperes

Converter Sector

Repetitive Peak Reverse Voltage	V_{RRM}	800	Volts
Recommended Input Voltage	E_a	220	Volts RMS
DC Output Current (3-Phase Full Wave Rectifying, $T_C = 140^\circ\text{C}$)*	I_O	75	Amperes
Surge Forward Current (sine Half-wave 1 Cycle Peak Value, $F = 60\text{Hz}$, Non-repetitive)	I_{FSM}	750	Amperes
Current Square Time (Value for One Cycle of Surge Current)	I^2t	2340	A^2s

* T_C , T_f measured point is just under the chips.

**Pulse width and repetition rate should be such that device junction temperature (T_j) does not exceed $T_{j(\text{max})}$ rating.

***Represents characteristics of the anti-parallel, emitter-to-collector free-wheel diode (FWDi).

CM75MX-12A
NX-Series CIB Module
(3Ø Converter + 3Ø Inverter + Brake)
75 Amperes/600 Volts

Electrical and Mechanical Characteristics, $T_j = 25^\circ\text{C}$ unless otherwise specified

Inverter Sector

Characteristics	Symbol	Test Conditions	Min.	Typ.	Max.	Units	
Collector Cutoff Current	I_{CES}	$V_{CE} = V_{CES}, V_{GE} = 0V$	—	—	1.0	mA	
Gate-Emitter Threshold Voltage	$V_{GE(th)}$	$I_C = 7.5\text{mA}, V_{CE} = 10V$	5	6	7	Volts	
Gate Leakage Current	I_{GES}	$V_{GE} = V_{GES}, V_{CE} = 0V$	—	—	0.5	μA	
Collector-Emitter Saturation Voltage	$V_{CE(sat)}$	$I_C = 75A, V_{GE} = 15V, T_j = 25^\circ\text{C}$	—	1.7	2.1	Volts	
		$I_C = 75A, V_{GE} = 15V, T_j = 125^\circ\text{C}$	—	1.9	—	Volts	
		$I_C = 75A, V_{GE} = 15V, \text{Chip}$	—	1.6	—	Volts	
Input Capacitance	C_{ies}		—	—	7.5	nF	
Output Capacitance	C_{oes}	$V_{CE} = 10V, V_{GE} = 0V$	—	—	1.0	nF	
Reverse Transfer Capacitance	C_{res}		—	—	0.3	nF	
Total Gate Charge	Q_G	$V_{CC} = 300V, I_C = 75A, V_{GE} = 15V$	—	200	—	nC	
Inductive Load	Turn-on Delay Time	$t_{d(on)}$	—	—	100	ns	
	Turn-on Rise Time	t_r	$V_{CC} = 300V, I_C = 75A,$	—	—	100	ns
	Turn-off Delay Time	$t_{d(off)}$	$V_{GE} = \pm 15V,$	—	—	300	ns
	Turn-off Fall Time	t_f	$R_G = 8.2\Omega, I_E = 75A,$	—	—	600	ns
Reverse Recovery Time*	t_{rr}	Inductive Load Switching Operation	—	—	200	ns	
Reverse Recovery Charge*	Q_{rr}		—	1.8	—	μC	
Emitter-Collector Voltage*	V_{EC}	$I_E = 75A, V_{GE} = 0V$	—	2.0	2.8	Volts	
		$I_E = 75A, V_{GE} = 0V, \text{Chip}$	—	1.9	—	Volts	

Thermal and Mechanical Characteristics, $T_j = 25^\circ\text{C}$ unless otherwise specified

Characteristics	Symbol	Test Conditions	Min.	Typ.	Max.	Units
Thermal Resistance, Junction to Case**	$R_{th(j-c)Q}$	Per IGBT	—	—	0.44	$^\circ\text{C/W}$
Thermal Resistance, Junction to Case**	$R_{th(j-c)D}$	Per FWDi	—	—	0.85	$^\circ\text{C/W}$
Contact Thermal Resistance**	$R_{th(c-f)}$	Thermal Grease Applied	—	0.015	—	$^\circ\text{C/W}$
Internal Gate Resistance	R_{Gint}	$T_C = 25^\circ\text{C}$	—	0	—	Ω
External Gate Resistance	R_G		8.0	—	83	Ω

*Represents characteristics of the anti-parallel, emitter-to-collector free-wheel diode (FWDi).

** T_C, t_f measured point is just under the chips.

CHIP LOCATION (TOP VIEW)

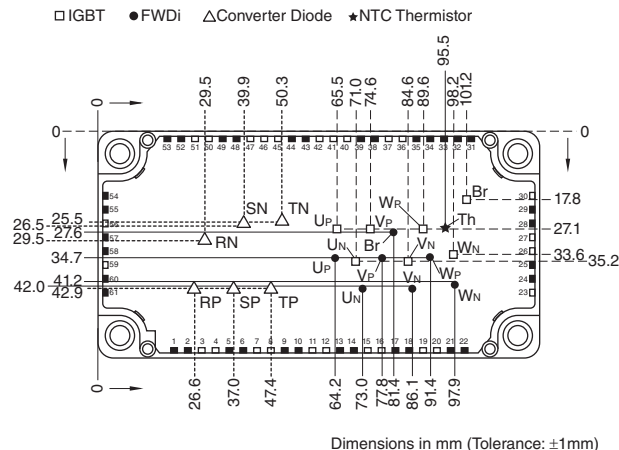

CM75MX-12A
NX-Series CIB Module
(3Ø Converter + 3Ø Inverter + Brake)
75 Amperes/600 Volts

Electrical and Mechanical Characteristics, $T_j = 25^\circ\text{C}$ unless otherwise specified

Brake Sector

Characteristics	Symbol	Test Conditions	Min.	Typ.	Max.	Units
Collector Cutoff Current	I_{CES}	$V_{CE} = V_{CES}, V_{GE} = 0V$	—	—	1.0	mA
Gate-Emitter Threshold Voltage	$V_{GE(th)}$	$I_C = 5mA$	5	6	7	Volts
Gate Leakage Current	I_{GES}	$V_{GE} = V_{GES}, V_{CE} = 0V$	—	—	0.5	μA
Collector-Emitter Saturation Voltage	$V_{CE(sat)}$	$I_C = 50A, V_{GE} = 15V, T_j = 25^\circ\text{C}$	—	1.7	2.1	Volts
		$I_C = 50A, V_{GE} = 15V, T_j = 125^\circ\text{C}$	—	1.9	—	Volts
		$I_C = 50A, V_{GE} = 15V, \text{Chip}$	—	1.6	—	Volts
Input Capacitance	C_{ies}		—	—	7.5	nF
Output Capacitance	C_{oes}	$V_{CE} = 10V, V_{GE} = 0V$	—	—	1.0	nF
Reverse Transfer Capacitance	C_{res}		—	—	0.3	nF
Total Gate Charge	Q_G	$V_{CC} = 300V, I_C = 50A, V_{GE} = 15V$	—	200	—	nC
Repetitive Reverse Current*	I_{RRM}	$V_R = V_{RRM}$	—	—	1.0	mA
Forward Voltage Drop *	V_F	$I_F = 50A$	—	2.3	3.2	Volts
		$I_F = 50A, \text{Chip}$	—	2.2	—	Volts

Thermal and Mechanical Characteristics, $T_j = 25^\circ\text{C}$ unless otherwise specified

Characteristics	Symbol	Test Conditions	Min.	Typ.	Max.	Units
Thermal Resistance, Junction to Case**	$R_{th(j-c)Q}$	Per IGBT	—	—	0.44	$^\circ\text{C/W}$
Thermal Resistance, Junction to Case**	$R_{th(j-c)D}$	Per FWDi	—	—	0.85	$^\circ\text{C/W}$
Contact Thermal Resistance**	$R_{th(c-f)}$	Thermal Grease Applied	—	0.015	—	$^\circ\text{C/W}$
Internal Gate Resistance	R_{Gint}	$T_C = 25^\circ\text{C}$	—	0	—	Ω
External Gate Resistance	R_G		13	—	125	Ω

Converter Sector, $T_j = 25^\circ\text{C}$ unless otherwise specified

Characteristics	Symbol	Test Conditions	Min.	Typ.	Max.	Units
Repetitive Peak Reverse Current	I_{RRM}	$V_R = V_{RRM}, T_j = 150^\circ\text{C}$	—	—	20	mA
Forward Voltage Drop	V_F	$I_F = 75A$	—	1.2	1.6	Volts
Thermal Resistance, Junction to Case**	$R_{th(j-c)}$	Per FWDi	—	—	0.24	K/W
Contact Thermal Resistance**	$R_{th(c-f)}$	Thermal Grease Applied	—	0.015	—	$^\circ\text{C/W}$

NTC Thermistor Sector, $T_j = 25^\circ\text{C}$ unless otherwise specified

Characteristics	Symbol	Test Conditions	Min.	Typ.	Max.	Units
Zero Power Resistance	R	$T_C = 25^\circ\text{C}$	4.85	5.00	5.15	k Ω
Deviation of Resistance	$\Delta R/R$	$T_C = 100^\circ\text{C}, R_{100} = 493\Omega$	-7.3	—	+7.8	%
B Constant	$B_{(25/50)}$	$B = (\ln R_1 - \ln R_2) / (1/T_1 - 1/T_2)^{***}$	—	3375	—	K
Power Dissipation	P_{25}	$T_C = 25^\circ\text{C}$	—	—	10	mW

*Represents characteristics of the anti-parallel, emitter-to-collector free-wheel diode (FWDi).

** T_C, T_f measured point is just under the chips.

*** R_1 : Resistance at Absolute Temperature $T_1(K), R_2$: Resistance at Absolute Temperature $T_2(K), T(K) = t(^\circ\text{C}) + 273.15$



Powerex, Inc., 173 Pavilion Lane, Youngwood, Pennsylvania 15697 (724) 925-7272

CM75MX-12A
NX-Series CIB Module
(3Ø Converter + 3Ø Inverter + Brake)
75 Amperes/600 Volts

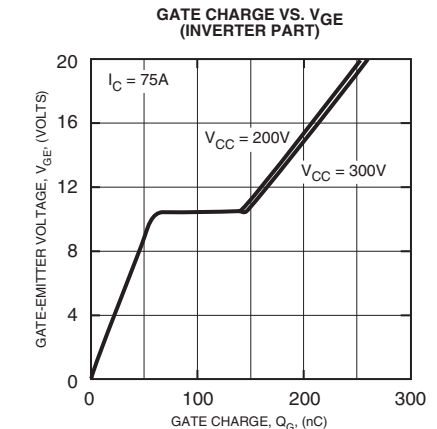
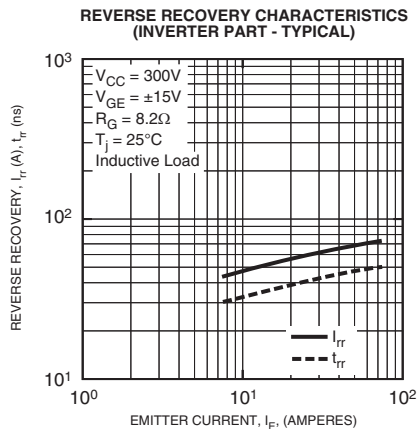
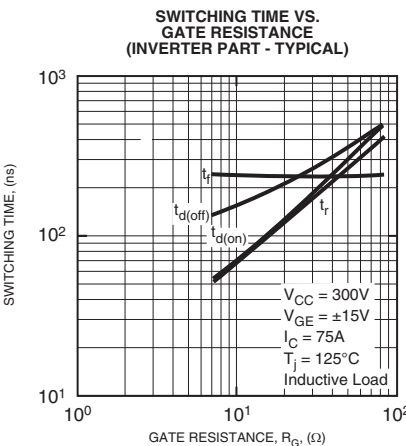
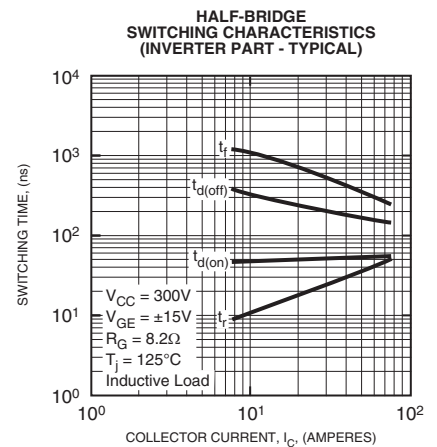
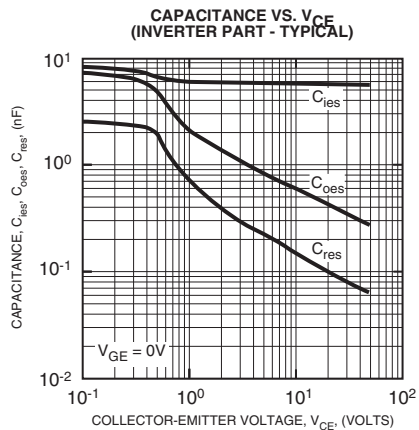
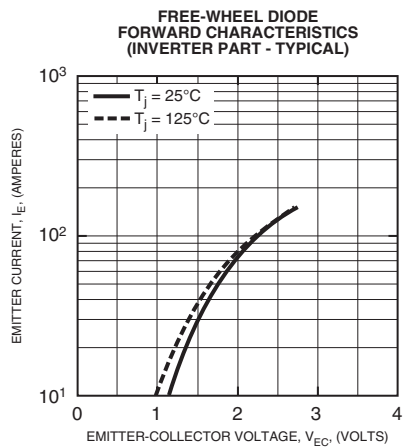
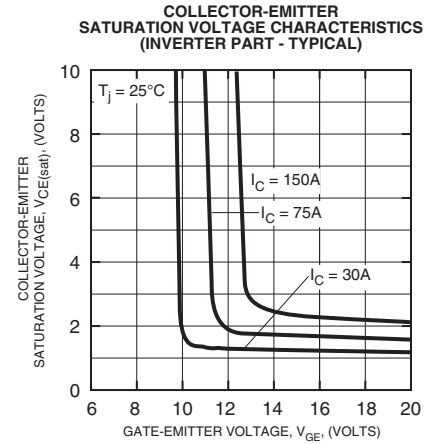
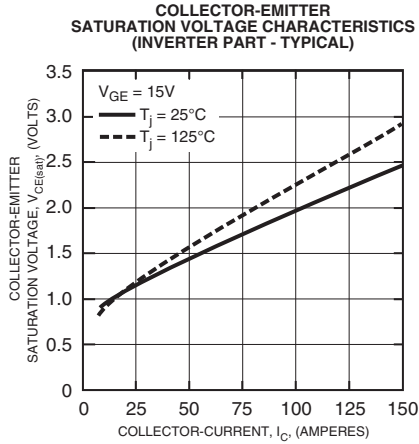
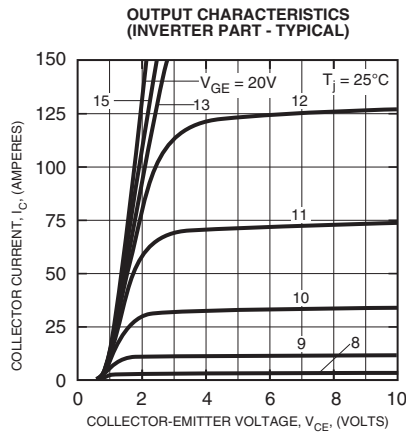

CM75MX-12A
NX-Series CIB Module
(3Ø Converter + 3Ø Inverter + Brake)
75 Amperes/600 Volts

