



CM600HA-24E

Powerex, Inc., 200 Hillis Street, Youngwood, Pennsylvania 15697-1800 (412) 925-7272
 Powerex, Europe, S.A. 428 Avenue G. Durand, BP107, 72003 Le Mans, France (43) 41.14.14

**Single IGBTMOD™
 E-Series Module
 600 Amperes/1200 Volts**

POWEREX INC

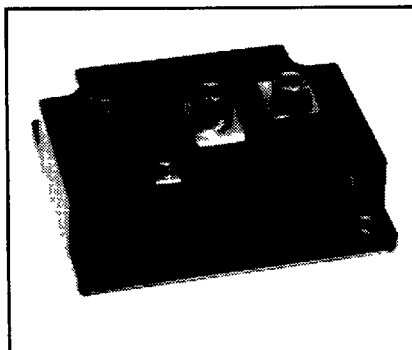
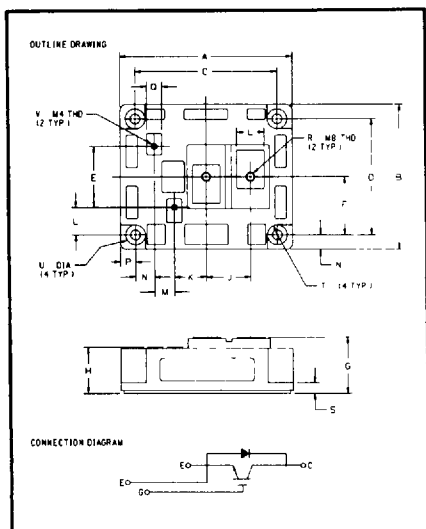

CM600HA-24E
Single IGBTMOD™ E-Series Module
 600 Amperes/1200 Volts

Description:

Powerex IGBTMOD™ Modules are designed for use in switching applications. Each module consists of one IGBT Transistor in a single configuration with a reverse-connected super-fast recovery free-wheel diode. All components and interconnects are isolated from the heat sinking baseplate, offering simplified system assembly and thermal management.

Features:

- Low Drive Power
- Low $V_{CE(sat)}$
- Discrete Super-Fast Recovery (150ns) Free-Wheel Diode
- High Frequency Operation (15-20kHz)
- Isolated Baseplate for Easy Heat Sinking

Applications:

- AC Motor Control
- Motion/Servo Control
- UPS
- Welding Power Supplies
- Laser Power Supplies

Ordering Information:

Example: Select the complete part module number you desire from the table below
 -i.e. CM600HA-24E is a 1200V (V_{CES}), 600 Ampere Single IGBTMOD™ Power Module.

CM600HA-24E
Outline Drawing

Dimensions	Inches	Millimeters
A	4.45	113.0
B	3.74	95.0
C	3.661±0.008	93.0±0.25
D	2.992±0.008	76.0±0.25
E	1.57	40.0
F	1.50	38.0
G	1.46 Max.	37.0 Max
H	1.20	30.5 Max
J	1.14	29.0
K	0.83	21.0
L	0.71	18.0
M	0.51	13.0
N	0.49	12.5
P	0.39	10.0
Q	0.35	9.0
R	M8 Metric	M8
S	0.28	7.0
T	0.26 R	R6.50
U	0.256 Dia.	Dia. 6.50
V	M4 Metric	M4

Type	Current Rating Amperes	V_{CES} Volts (x 50)
CM	600	24



POWEREX INC

Powerex, Inc., 200 Hillis Street, Youngwood, Pennsylvania 15697-1800 (412) 925-7272
 Powerex, Europe, S.A. 428 Avenue G. Durand, BP107, 72003 Le Mans, France (43) 41.14.14

CM600HA-24E
 Single IGBTMOD™ E-Series Module
 600 Amperes/1200 Volts

Absolute Maximum Ratings, $T_j = 25^\circ\text{C}$ unless otherwise specified

Ratings	Symbol	CM600HA-24E	Units
Junction Temperature	T_j	-40 to 150	$^\circ\text{C}$
Storage Temperature	T_{stg}	-40 to 125	$^\circ\text{C}$
Collector-Emitter Voltage (G-E SHORT)	V_{CES}	1200	Volts
Gate-Emitter Voltage	V_{GES}	± 20	Volts
Collector Current	I_C	600	Amperes
Peak Collector Current	I_{CM}	1200*	Amperes
Diode Forward Current	I_{FM}	600	Amperes
Diode Forward Surge Current	I_{FM}	1200*	Amperes
Power Dissipation	P_d	4200	Watts
Max. Mounting Torque M8 Terminal Screws	-	72	in-lb
Max. Mounting Torque M6 Mounting Screws	-	26	in-lb
Module Weight (Typical)	-	790	Grams
V Isolation	V_{RMS}	2500	Volts

* Pulse width and repetition rate should be such that device junction temperature does not exceed the device rating

Static Electrical Characteristics, $T_j = 25^\circ\text{C}$ unless otherwise specified

Characteristics	Symbol	Test Conditions	Min.	Typ.	Max.	Units
Collector-Cutoff Current	I_{CES}	$V_{CE} = V_{CES}, V_{GE} = 0V$	-	-	2.0	mA
Gate Leakage Current	I_{GES}	$V_{GE} = V_{GES}, V_{CE} = 0V$	-	-	0.5	μA
Gate-Emitter Threshold Voltage	$V_{GE(th)}$	$I_C = 60\text{mA}, V_{CE} = 10V$	3.5	5.0	6.5	Volts
Collector-Emitter Saturation Voltage	$V_{CE(sat)}$	$I_C = 600A, V_{GE} = 15V$	-	-	4.0**	Volts
		$I_C = 600A, V_{GE} = 15V, T_j = 150^\circ\text{C}$	-	-	4.0**	Volts
Total Gate Charge	Q_G	$V_{CC} = 300V, I_C = 600A, V_{GS} = 15V$	-	6300	-	nC
Diode Forward Voltage	V_{FM}	$I_C = 600A, V_{GS} = 0V$	-	-	2.5	Volts

** Pulse width and repetition rate should be such that device junction temperature rise is negligible

Dynamic Electrical Characteristics, $T_j = 25^\circ\text{C}$ unless otherwise specified

Characteristics	Symbol	Test Conditions	Min.	Typ.	Max.	Units	
Input Capacitance	C_{ies}	$V_{GE} = 0V, V_{CE} = 10V, f = 1\text{MHz}$	-	-	240	nF	
Output Capacitance	C_{oes}		-	-	72	nF	
Reverse Transfer Capacitance	C_{res}		-	-	48	nF	
Resistive	Turn-on Delay Time	$V_{CC} = 600V, I_C = 600A,$ $V_{GE1} = V_{GE2} = 15V, R_G = 2.1$	-	-	-	ns	
Load	Rise Time		t_r	-	-	-	ns
Switch Times	Turn-off Delay Time		$t_d(off)$	-	-	-	ns
	Fall Time		t_f	-	-	400	ns
Diode Reverse Recovery Time	t_{rr}		$I_E = 600A, di_E/dt = -120A/\mu\text{s}$	-	-	300	ns
Diode Reverse Recovery Charge	Q_{rr}	$I_E = 600A, di_E/dt = -120A/\mu\text{s}$	-	13	-	μC	

Thermal and Mechanical Characteristics, $T_j = 25^\circ\text{C}$ unless otherwise specified

Characteristics	Symbol	Test Conditions	Min.	Typ.	Max.	Units
Thermal Resistance, Junction to Case	$R_{th(j-c)}$	Per IGBT	-	-	0.03	$^\circ\text{C/W}$
Thermal Resistance, Junction to Case	$R_{th(j-c)}$	Per Free Wheel Diode	-	-	0.06	$^\circ\text{C/W}$
Contact Thermal Resistance	$R_{th(c-f)}$	Per Module	-	-	0.03	$^\circ\text{C/W}$

Powerex, Inc., 200 Hillis Street, Youngwood, Pennsylvania 15697-1800 (412) 925-7272
 Powerex, Europe, S.A. 428 Avenue G. Durand, BP107, 72003 Le Mans, France (43) 41.14.14

CM600HA-24E
Single IGBTMOD™ E-Series Module
 600 Amperes/1200 Volts

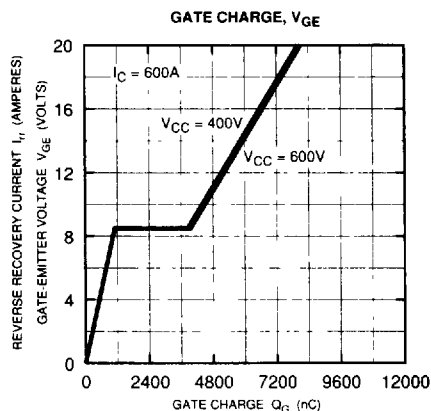
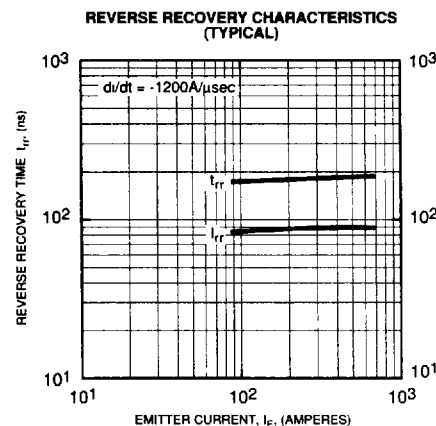
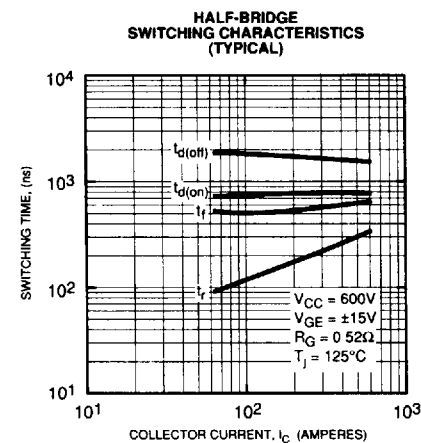
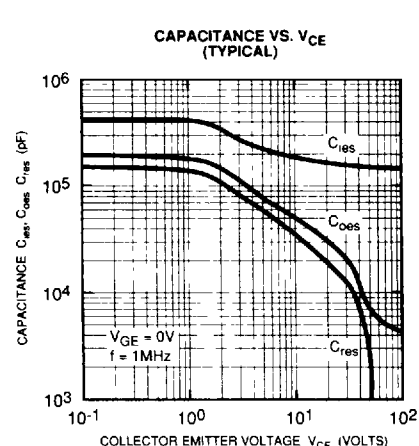
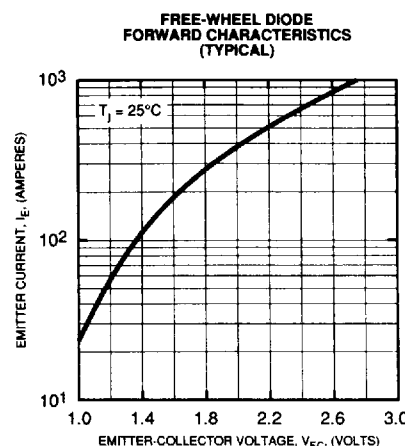
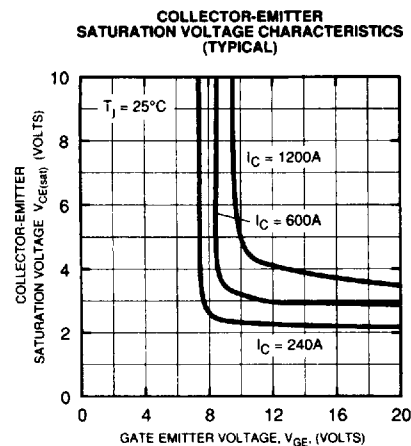
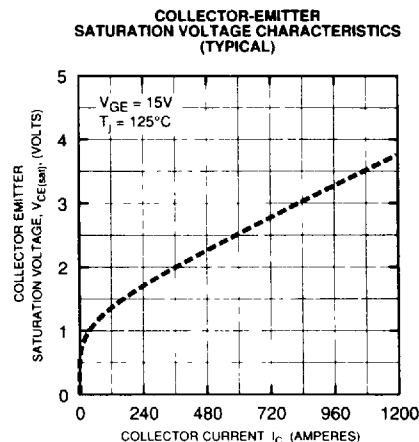
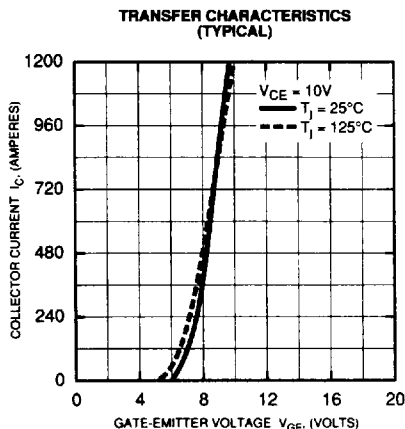
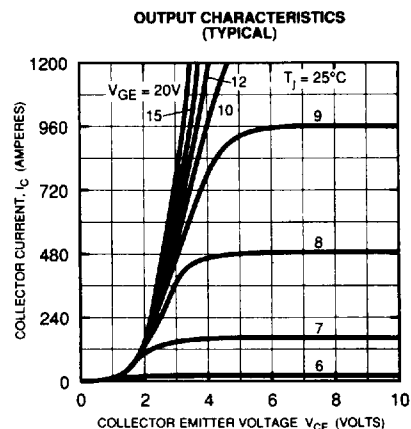

Powerex, Inc., 200 Hillis Street, Youngwood, Pennsylvania 15697-1800 (412) 925-7272
 Powerex, Europe, S.A. 428 Avenue G. Durand, BP107, 72003 Le Mans, France (43) 41.14.14

CM600HA-24E
Single IGBTMOD™ E-Series Module
 600 Amperes/1200 Volts

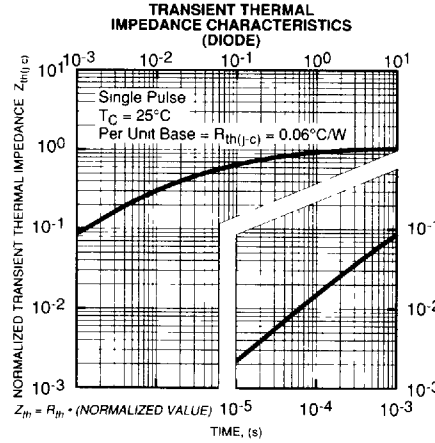
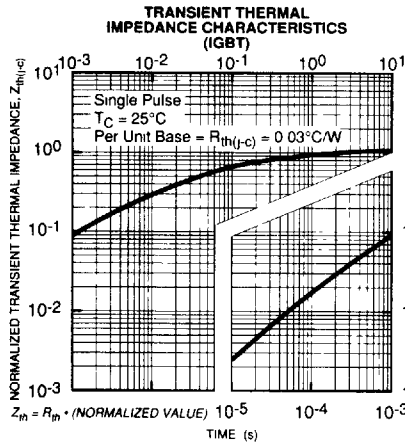

SWITCHING TIME TEST CIRCUITS & WAVEFORMS

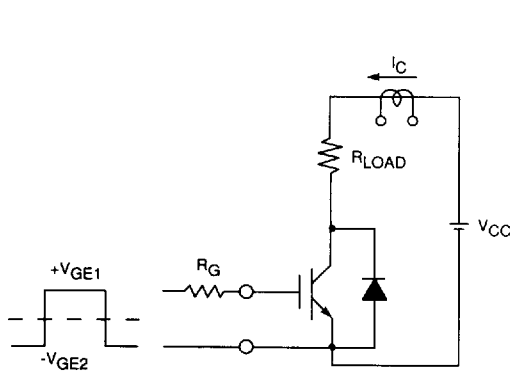

RESISTANCE LOAD SWITCHING TEST CIRCUIT

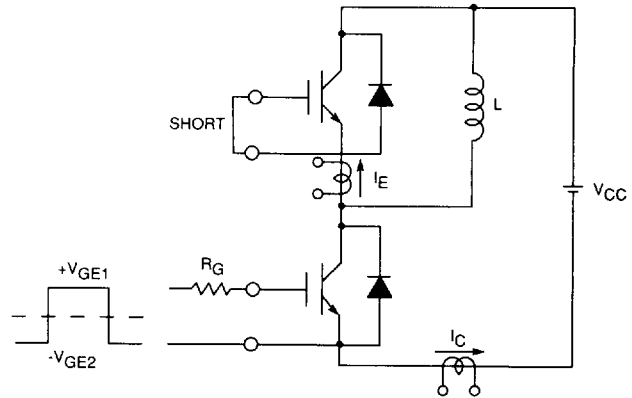

HALF-BRIDGE SWITCHING TEST CIRCUIT

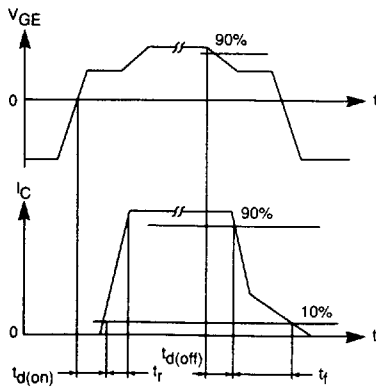

SWITCHING TIME TEST WAVEFORMS

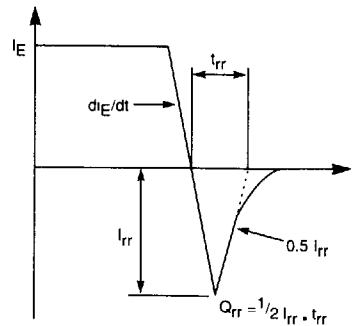

t_{rr}, Q_{rr} WAVEFORMS