

**SCR/Diode
POW-R-BLOK™ Modules
130 Amperes/1200-1600 Volts**

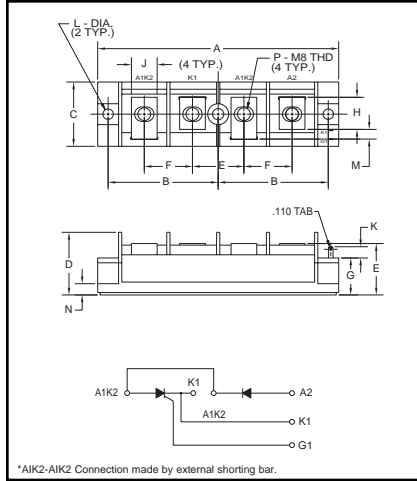

**CM521213, CM521613
SCR/Diode
POW-R-BLOK™ Modules
130 Amperes/1200-1600 Volts**

Outline Drawing

Dimension	Inches	Millimeters
A	5.906	150
B	2.697±0.02	68.5±0.2
C	1.575	40
D	1.535	39
E	1.260	32
F	1.181	30
G	0.906	23
H	0.787	20
J	0.630	16
K	0.276	7
L	0.256±0.008 Dia.	Dia. 6.5±0.2
M	0.236	6
N	0.197	5
P	M8 Metric	M8

Description:

Powerex SCR/Diode POW-R-BLOK™ Modules are designed for use in applications requiring Half-Control and isolated packaging. The modules are isolated for easy mounting with other components on common heatsinks.

Features:

- Isolated Mounting
- Glass Passivated Chips
- Metal Baseplate
- Low Thermal Impedance

Applications:

- Battery Supplies
- Bridge Circuits
- AC and DC Motor Control
- Tap Changers
- Lighting Control

Ordering Information:

Select the complete eight digit module part number you desire from the table below. Example: CM521613 is a 1600 Volt, 130 Ampere SCR/Diode POW-R-BLOK™ Module.

Type	Voltage Volts (x100)	Current Rating Amperes (x10)
CM52	12 16	13



Powerex, Inc., 200 Hillis Street, Youngwood, Pennsylvania 15697-1800 (724) 925-7272

CM521213, CM521613
 SCR/Diode POW-R-BLOK™ Modules
 130 Amperes/1200-1600 Volts

Absolute Maximum Ratings

Characteristics	Symbol	CM521213	CM521613	Units
Peak Forward Blocking Voltage	V_{DRM}	1200	1600	Volts
Transient Peak Forward Blocking Voltage (Non-Repetitive), $t < 5ms$	V_{DSM}	1350	1700	Volts
DC Forward Blocking Voltage	$V_{D(DC)}$	960	1280	Volts
Peak Reverse Blocking Voltage	V_{RRM}	1200	1600	Volts
Transient Peak Reverse Blocking Voltage (Non-Repetitive), $t < 5ms$	V_{RSM}	1350	1700	Volts
DC Reverse Blocking Voltage	$V_{R(DC)}$	960	1280	Volts
RMS On-State Current	$I_T(RMS), I_F(RMS)$	205	205	Amperes
Average On-State Current, $T_C = 78^\circ C$	$I_T(AV), I_F(AV)$	130	130	Amperes
Peak One-Cycle Surge (Non-Repetitive) On-State Current (60Hz)	I_{TSM}, I_{FSM}	2600	2600	Amperes
Peak One-Cycle Surge (Non-Repetitive) On-State Current (50Hz)	I_{TSM}, I_{FSM}	2365	2365	Amperes
I^2t (for Fusing), 8.3 milliseconds	I^2t	28000	28000	A^2sec
Critical Rate-of-Rise of On-State Current*	di/dt	100	100	Amperes/ μs
Peak Gate Power Dissipation	P_{GM}	10	10	Watts
Average Gate Power Dissipation	$P_{G(AV)}$	3.0	3.0	Watts
Peak Forward Gate Voltage	V_{GFM}	10	10	Volts
Peak Reverse Gate Voltage	V_{GRM}	5.0	5.0	Volts
Peak Forward Gate Current	I_{GFM}	4.0	4.0	Amperes
Storage Temperature	T_{STG}	-40 to 125	-40 to 125	$^\circ C$
Operating Temperature	T_j	-40 to 125	-40 to 125	$^\circ C$
Maximum Mounting Torque M6 Mounting Screw	—	26	26	in.-lb.
Maximum Mounting Torque M8 Terminal Screw	—	72	72	in.-lb.
Module Weight (Typical)	—	300	300	Grams
V Isolation	V_{RMS}	2500	2500	Volts

* $T_j = 125^\circ C, I_G = 1.0A, V_D = 1/2 V_{DRM}$



Powerex, Inc., 200 Hillis Street, Youngwood, Pennsylvania 15697-1800 (724) 925-7272

CM521213, CM521613
SCR/Diode POW-R-BLOK™ Modules
130 Amperes/1200-1600 Volts

Electrical and Thermal Characteristics, $T_j = 25^\circ\text{C}$ unless otherwise specified

Characteristics	Symbol	Test Conditions	CM521213/CM521613	Units
Blocking State Maximums				
Forward Leakage Current, Peak	I_{DRM}	$T_j = 125^\circ\text{C}$, $V_{\text{DRM}} = \text{Rated}$	30	mA
Reverse Leakage Current, Peak	I_{RRM}	$T_j = 125^\circ\text{C}$, $V_{\text{RRM}} = \text{Rated}$	30	mA
Conducting State Maximums				
Peak On-State Voltage	V_{FM} , V_{TM}	$I_{\text{FM}} = 390\text{A}$, $I_{\text{TM}} = 390\text{A}$	1.3	Volts
Switching Minimums				
Critical Rate-of-Rise of Off-State Voltage	dv/dt	$T_j = 125^\circ\text{C}$, $V_{\text{D}} = 2/3 V_{\text{DRM}}$	500	Volts/ μs
Thermal Maximums				
Thermal Resistance, Junction-to-Case	$R_{\theta(\text{J-C})}$	Per Module	0.22	$^\circ\text{C/Watt}$
Thermal Resistance, Case-to-Sink (Lubricated)	$R_{\theta(\text{C-S})}$	Per Module	0.05	$^\circ\text{C/Watt}$
Gate Parameters Maximums				
Gate Current-to-Trigger	I_{GT}	$V_{\text{D}} = 6\text{V}$, $R_{\text{L}} = 2\Omega$	100	mA
Gate Voltage-to-Trigger	V_{GT}	$V_{\text{D}} = 6\text{V}$, $R_{\text{L}} = 2\Omega$	3.0	Volts
Non-Triggerring Gate Voltage	V_{GDM}	$T_j = 125^\circ\text{C}$, $V_{\text{D}} = 1/2 V_{\text{DRM}}$	0.25	Volts

CM521213, CM521613
SCR/Diode POW-R-BLOK™ Modules
 130 Amperes/1200-1600 Volts

MAXIMUM ON-STATE CHARACTERISTICS

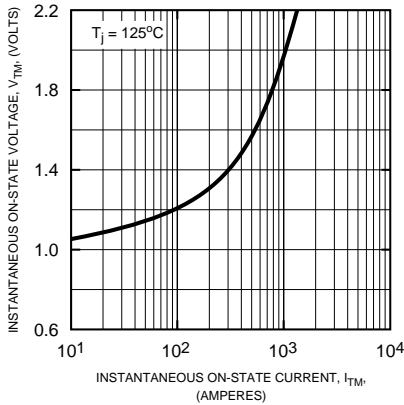

MAXIMUM ALLOWABLE PEAK SURGE (NON-REPETITIVE) CURRENT

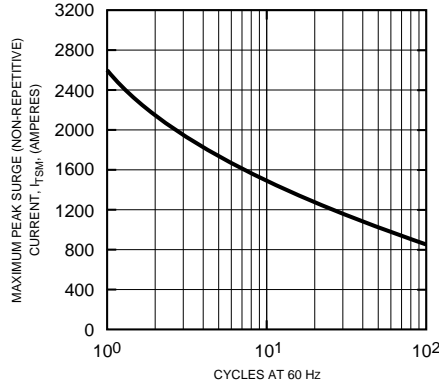

MAXIMUM ALLOWABLE CASE TEMPERATURE (SINUSOIDAL WAVEFORM)

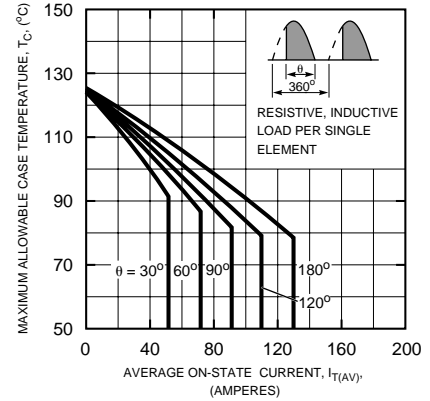

MAXIMUM ON-STATE POWER DISSIPATION (SINUSOIDAL WAVEFORM)

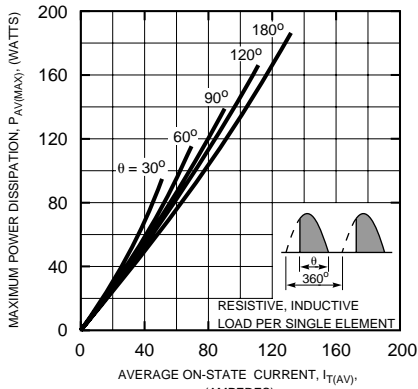

MAXIMUM ALLOWABLE CASE TEMPERATURE (RECTANGULAR WAVEFORM)

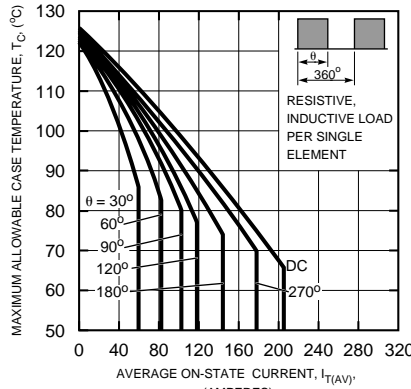

MAXIMUM AVERAGE ON-STATE POWER DISSIPATION (RECTANGULAR WAVEFORM)

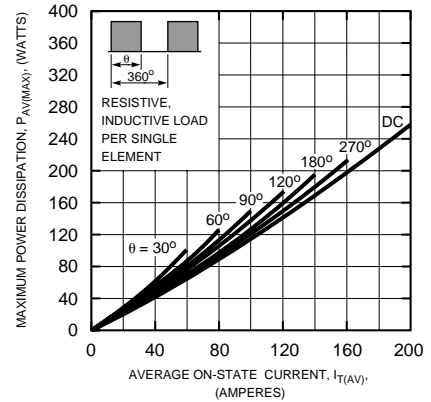

TRANSIENT THERMAL IMPEDANCE CHARACTERISTICS (JUNCTION-TO-CASE)

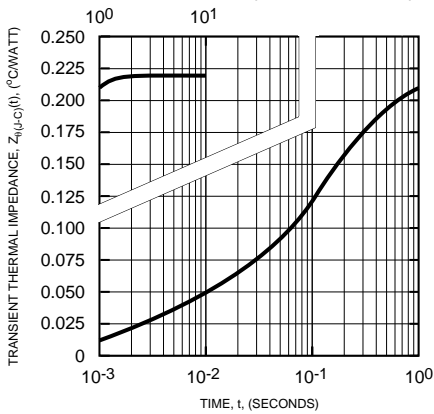

TRIGGERING CHARACTERISTICS

