

MITSUBISHI IGBT MODULES  
**CM50MD1-12H**  
 MEDIUM POWER SWITCHING USE  
 FLAT-BASE TYPE, INSULATED TYPE

**CM50MD1-12H**

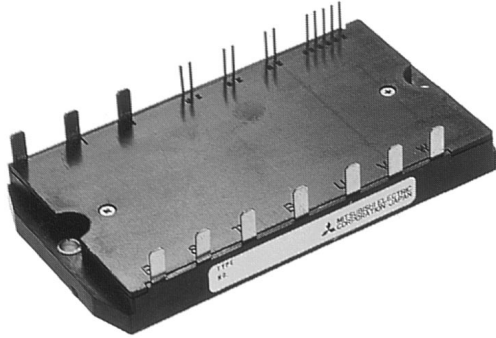

- IC ..... 50A
  - V<sub>CES</sub> ..... 600V
  - Insulated Type
  - CIB Module  
 3φ Inverter+3φ Converter
  - UL Recognized
- Yellow Card No. E80276 (N)  
 File No. E80271

**APPLICATION**

AC & DC motor controls, General purpose inverters, Servo controls, NC, Robotics, UPS

**OUTLINE DRAWING & CIRCUIT DIAGRAM**

Dimensions in mm

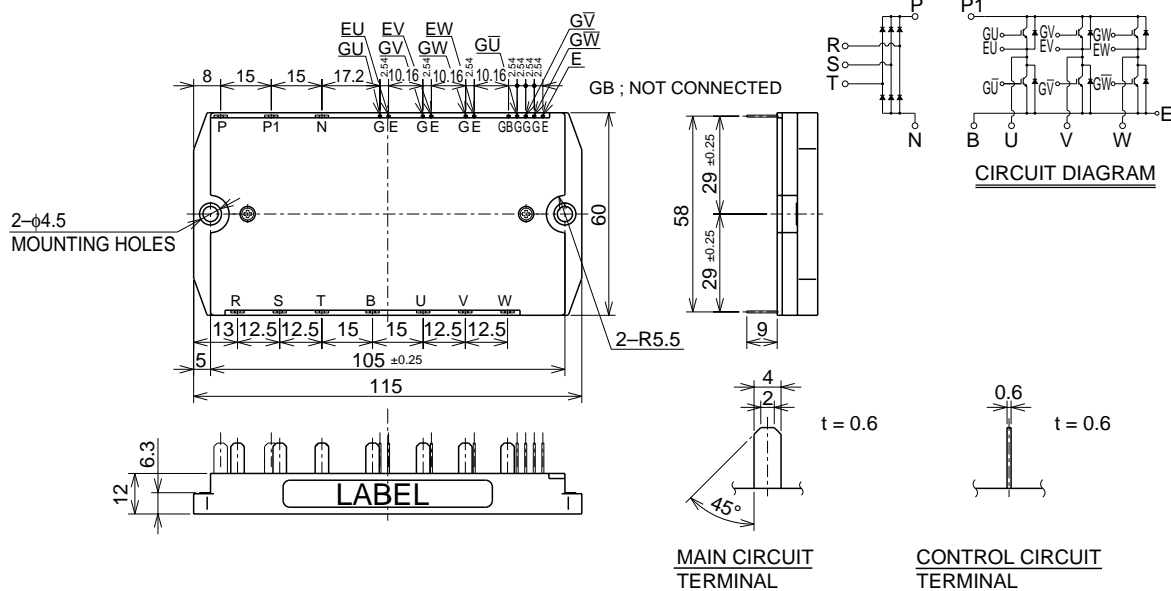

## CM50MD1-12H

MEDIUM POWER SWITCHING USE  
FLAT-BASE TYPE, INSULATED TYPE**MAXIMUM RATINGS** ( $T_j = 25^\circ\text{C}$ )  
**INVERTER PART**

Symbol	Parameter	Condition	Rating	Unit
V <sub>CES</sub>	Collector-emitter voltage	G – E Short	600	V
V <sub>GES</sub>	Gate-emitter voltage	C – E Short	±20	V
I <sub>C</sub>	Collector Current	T <sub>C</sub> = 25°C	50	A
I <sub>CM</sub>		PULSE (Note. 2)	100	A
I <sub>E</sub> (Note. 1)	Emitter Current	T <sub>C</sub> = 25°C	50	A
I <sub>EM</sub> (Note. 1)		PULSE (Note. 2)	100	A
P <sub>C</sub> (Note. 3)	Maximum collector dissipation	T <sub>f</sub> = 25°C	104	W

**CONVERTER PART**

Symbol	Parameter	Condition	Rating	Unit
V <sub>RRM</sub>	Repetitive peak reverse voltage		800	V
E <sub>a</sub>	Recommended AC input voltage		220	V
I <sub>O</sub>	DC output current	3 $\phi$ rectifying circuit T <sub>f</sub> = 106°C	50	A
I <sub>FSM</sub>	Surge (non-repetitive) forward current	1 cycle at 60Hz, peak value Non-repetitive	550	A
I <sup>2</sup> t	I <sup>2</sup> t for fusing	Value for one cycle of surge current	1.2X10 <sup>3</sup>	A <sup>2</sup> s

**COMMON RATING**

Symbol	Parameter	Condition	Rating	Unit
T <sub>j</sub>	Junction temperature		-40 ~ +150	°C
T <sub>stg</sub>	Storage temperature		-40 ~ +125	°C
V <sub>iso</sub>	Isolation voltage	AC 1 min.	2500	V
—	Mounting torque	Mounting M4 screw	0.98 ~ 1.47	N · m
—	Weight	Typical value	100	g

## CM50MD1-12H

MEDIUM POWER SWITCHING USE  
FLAT-BASE TYPE, INSULATED TYPEELECTRICAL CHARACTERISTICS ( $T_j = 25^\circ\text{C}$ )  
INVERTER PART

Symbol	Parameter	Test conditions	Limits			Unit
			Min.	Typ.	Max.	
ICES	Collector cutoff current	$V_{CE} = V_{CES}, V_{GE} = 0V$	—	—	1	mA
$V_{GE(th)}$	Gate-emitter threshold voltage	$I_C = 5mA, V_{CE} = 10V$	4.5	6	7.5	V
IGES	Gate-emitter cutoff current	$V_{GE} = V_{GES}, V_{CE} = 0V$	—	—	0.5	$\mu A$
$V_{CE(sat)}$	Collector-emitter saturation voltage	$T_j = 25^\circ\text{C}$	—	2.2	2.8	V
		$T_j = 150^\circ\text{C}$	—	—	—	
$C_{ies}$	Input capacitance	$V_{CE} = 10V$ $V_{GE} = 0V$	—	—	5.0	nF
$C_{oes}$	Output capacitance		—	—	3.8	nF
$C_{res}$	Reverse transfer capacitance		—	—	1.0	nF
QG	Total gate charge	$V_{CC} = 300V, I_C = 50A, V_{GE} = 15V$	—	150	—	nC
$t_d(on)$	Turn-on delay time	$V_{CC} = 300V, I_C = 50A$	—	—	120	ns
$t_r$	Turn-on rise time	$V_{GE1} = V_{GE2} = 15V$	—	—	300	ns
$t_d(off)$	Turn-off delay time	$R_G = 13\Omega$	—	—	200	ns
$t_f$	Turn-off fall time	Resistive load	—	—	300	ns
$V_{EC}$ (Note. 1)	Emitter-collector voltage	$I_E = 50A, V_{GE} = 0V$	—	—	2.8	V
$t_{rr}$ (Note. 1)	Reverse recovery time	$I_E = 50A, V_{GE} = 0V$	—	—	110	ns
$Q_{rr}$ (Note. 1)	Reverse recovery charge	$di_e / dt = -100A / \mu s$	—	0.14	—	$\mu C$
$R_{th(j-Q)}$ (Note. 5)	Thermal resistance	IGBT part, Per 1/6 module	—	—	1.2	$^\circ\text{C/W}$
$R_{th(j-R)}$ (Note. 5)		FWDi part, Per 1/6 module	—	—	1.9	$^\circ\text{C/W}$

## CONVERTER PART

Symbol	Parameter	Condition	Limits			Unit
			Min.	Typ.	Max.	
IRRM	Repetitive reverse current	$V_R = V_{RRM}, T_j = 150^\circ\text{C}$	—	—	8	mA
VFM	Forward voltage drop	$I_F = 50A$	—	—	1.5	V
$R_{th(j-I)}$ (Note. 5)	Thermal resistance	Per 1/6 module	—	—	1.7	$^\circ\text{C/W}$

- Note 1.  $I_E$ ,  $V_{EC}$ ,  $t_{rr}$ ,  $Q_{rr}$  &  $di_e/dt$  represent characteristics of the anti-parallel, emitter to collector free-wheel diode.  
 2. Pulse width and repetition rate should be such that the device junction temp. ( $T_j$ ) does not exceed  $T_{jmax}$  rating.  
 3. Junction temperature ( $T_j$ ) should not increase beyond  $150^\circ\text{C}$ .  
 4. Pulse width and repetition rate should be such as to cause negligible temperature rise.  
 5. Thermal resistance is specified under following conditions.  
 • The conductive grease applied, between module and fin.  
 • Al plate is used as fin.

# CM50MD1-12H

MEDIUM POWER SWITCHING USE  
FLAT-BASE TYPE, INSULATED TYPE

## PERFORMANCE CURVES

**OUTPUT CHARACTERISTICS (TYPICAL)**

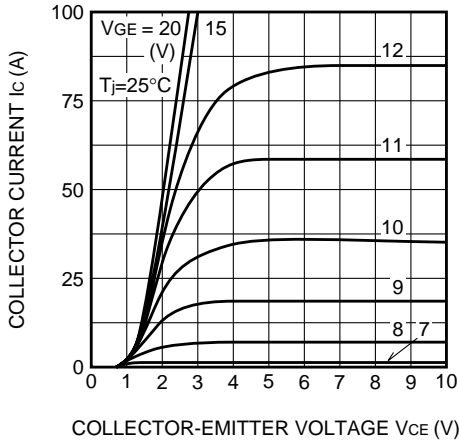

**TRANSFER CHARACTERISTICS (TYPICAL)**

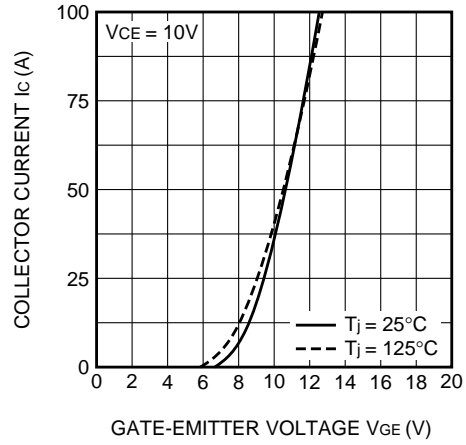

**COLLECTOR-EMITTER SATURATION VOLTAGE CHARACTERISTICS (TYPICAL)**

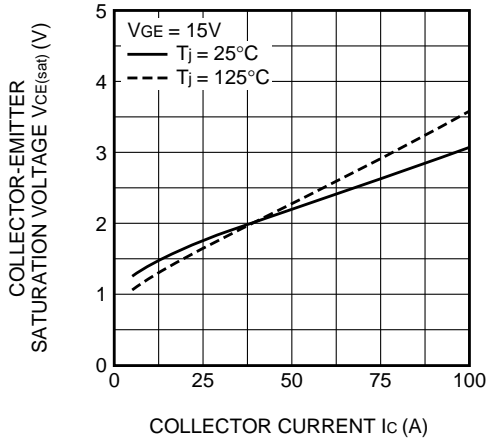

**COLLECTOR-EMITTER SATURATION VOLTAGE CHARACTERISTICS (TYPICAL)**

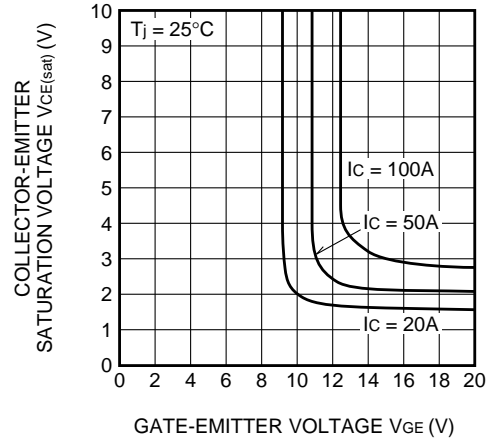

**FREE-WHEEL DIODE FORWARD CHARACTERISTICS (TYPICAL)**

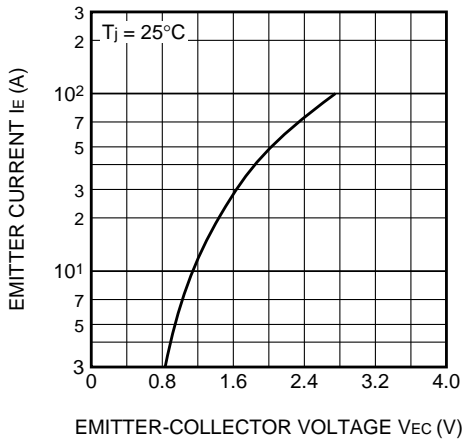

**CAPACITANCE VS. Vce (TYPICAL)**

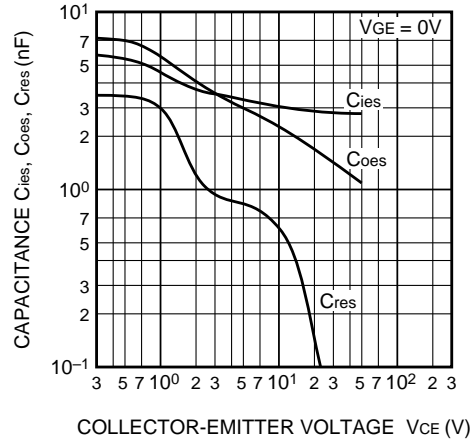

# CM50MD1-12H

MEDIUM POWER SWITCHING USE  
FLAT-BASE TYPE, INSULATED TYPE

**HALF-BRIDGE SWITCHING CHARACTERISTICS (TYPICAL)**

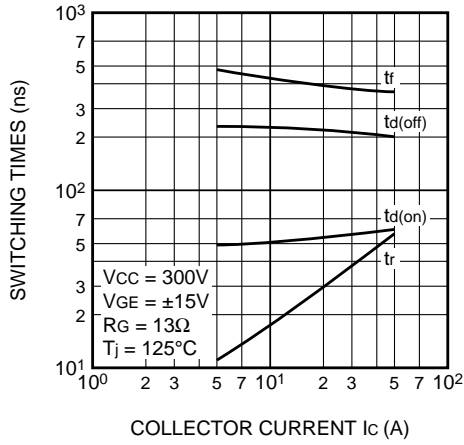

**REVERSE RECOVERY CHARACTERISTICS OF FREE-WHEEL DIODE (TYPICAL)**

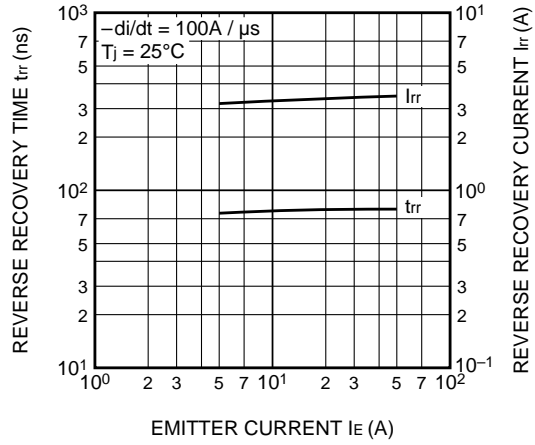

**TRANSIENT THERMAL IMPEDANCE CHARACTERISTICS (IGBT part)**

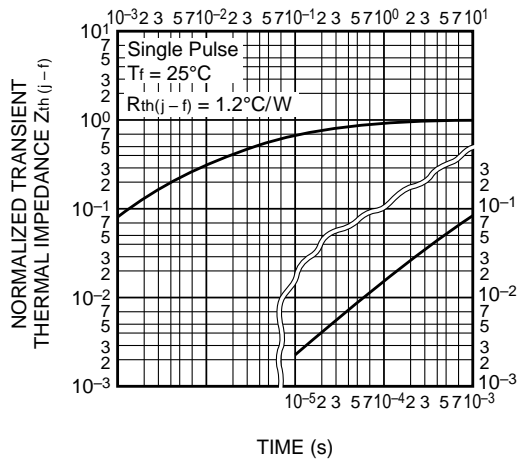

**TRANSIENT THERMAL IMPEDANCE CHARACTERISTICS (FWDi part)**

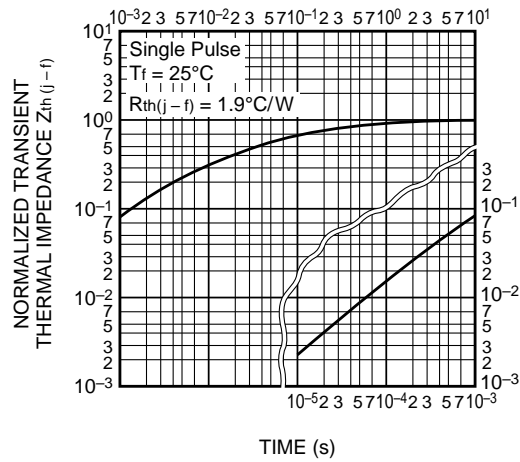

**$V_{GE}$  - GATE CHARGE (TYPICAL)**

