

### Chopper IGBTMOD™ E-Series Module 50 Amperes/1200 Volts

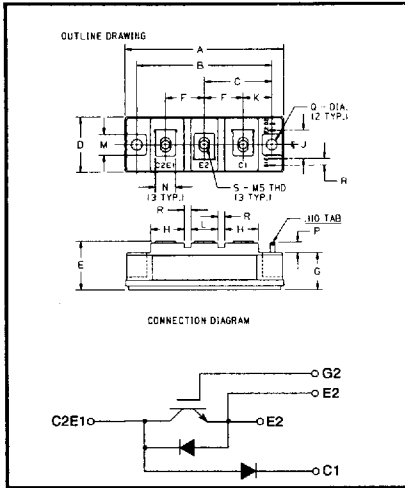

**CM50E3Y-24E**  
Outline Drawing

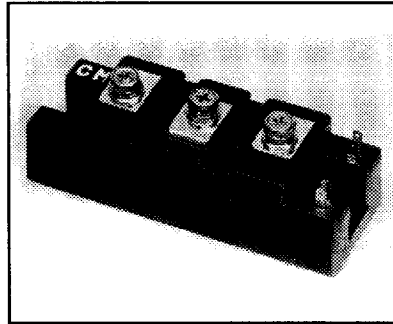

**CM50E3Y-24E**  
Chopper IGBTMOD™ E-Series Module  
50 Amperes/1200 Volts

#### Description:

Powerex Chopper IGBTMOD™ Modules are designed for use in switching applications. Each module consists of one IGBT Transistor having a reverse-connected super-fast recovery free-wheel diode and an anode-collector connected super-fast recovery free-wheel diode. All components and interconnects are isolated from the heat sinking baseplate, offering simplified system assembly and thermal management.

#### Features:

- Low Drive Power
- Low  $V_{CE(sat)}$
- Discrete Super-Fast Recovery (150ns) Free-Wheel Diode
- High Frequency Operation (15-20kHz)
- Isolated Baseplate for Easy Heat Sinking

#### Applications:

- DC Motor Control
- Boost Regulator

#### Ordering Information:

Example: Select the complete part module number you desire from the table below

-i.e. CM50E3Y-24E is a 1200V ( $V_{CES}$ ), 50 Ampere Chopper IGBTMOD™ Power Module.

Type	Current Rating Amperes	$V_{CES}$ Volts (x 50)
CM	50	24

Dimensions	Inches	Millimeters
A	3.70	94.0
B	3.150±0.01	80.0±0.25
C	1.57	40.0
D	1.34	34.0
E	1.22 Max.	31.0 Max.
F	0.90	23.0
G	0.85	21.5
H	0.79	20.0
J	0.71	18.0
K	0.67	17.0
L	0.63	16.0
M	0.51	13.0
N	0.47	12.0
P	0.28	7.0
Q	0.265 Dia.	Dia. 6.5
R	0.16	4.0
S	M5 Metric	M5



Powerex, Inc., 200 Hillis Street, Youngwood, Pennsylvania 15697-1800 (412) 925-7272

**CM50E3Y-24E**  
**Chopper IGBTMOD™ E-Series Module**  
 50 Amperes/1200 Volts

**Absolute Maximum Ratings,  $T_J = 25^\circ\text{C}$  unless otherwise specified**

Ratings	Symbol	CM50E3Y-24E	Units
Junction Temperature	$T_J$	-40 to 150	$^\circ\text{C}$
Storage Temperature	$T_{\text{stg}}$	-40 to 125	$^\circ\text{C}$
Collector-Emitter Voltage (G-E SHORT)	$V_{\text{CES}}$	1200	Volts
Gate-Emitter Voltage	$V_{\text{GES}}$	$\pm 20$	Volts
Collector Current	$I_C$	50	Amperes
Peak Collector Current	$I_{\text{CM}}$	100*	Amperes
Diode Forward Current	$I_{\text{FM}}$	50	Amperes
Diode Forward Surge Current	$I_{\text{FM}}$	100*	Amperes
Power Dissipation	$P_d$	400	Watts
Max. Mounting Torque M5 Terminal Screws	-	17	in-lb
Max. Mounting Torque M6 Mounting Screws	-	26	in-lb
Module Weight (Typical)	-	190	Grams
V Isolation	$V_{\text{RMS}}$	2500	Volts

\* Pulse width and repetition rate should be such that device junction temperature does not exceed the device rating.

**Static Electrical Characteristics,  $T_J = 25^\circ\text{C}$  unless otherwise specified**

Characteristics	Symbol	Test Conditions	Min.	Typ.	Max.	Units
Collector-Cutoff Current	$I_{\text{CES}}$	$V_{\text{CE}} = V_{\text{CES}}, V_{\text{GE}} = 0\text{V}$	-	-	1.0	mA
Gate Leakage Current	$I_{\text{GES}}$	$V_{\text{GE}} = V_{\text{GES}}, V_{\text{CE}} = 0\text{V}$	-	-	0.5	$\mu\text{A}$
Gate-Emitter Threshold Voltage	$V_{\text{GE(th)}}$	$I_C = 5\text{mA}, V_{\text{CE}} = 10\text{V}$	3.5	5.0	6.5	Volts
Collector-Emitter Saturation Voltage	$V_{\text{CE(sat)}}$	$I_C = 50\text{A}, V_{\text{GE}} = 15\text{V}$	-	-	4.0**	Volts
		$I_C = 50\text{A}, V_{\text{GE}} = 15\text{V}, T_J = 150^\circ\text{C}$	-	-	4.0**	Volts
Total Gate Charge	$Q_G$	$V_{\text{CC}} = 600\text{V}, I_C = 50\text{A}, V_{\text{GS}} = 15\text{V}$	-	530	-	nC
Diode Forward Voltage	$V_{\text{FM}}$	$I_E = 50\text{A}, V_{\text{GE}} = 0\text{V}$	-	-	2.5	Volts

\*\* Pulse width and repetition rate should be such that device junction temperature rise is negligible.

**Dynamic Electrical Characteristics,  $T_J = 25^\circ\text{C}$  unless otherwise specified**

Characteristics	Symbol	Test Conditions	Min.	Typ.	Max.	Units
Input Capacitance	$C_{\text{ies}}$		-	-	20	nF
Output Capacitance	$C_{\text{oes}}$	$V_{\text{GE}} = 0\text{V}, V_{\text{CE}} = 10\text{V}, f = 1\text{MHz}$	-	-	6	nF
Reverse Transfer Capacitance	$C_{\text{res}}$		-	-	4	nF
Resistive	Turn-on Delay Time	$V_{\text{CC}} = 600\text{V}, I_C = 50\text{A}, V_{\text{GE1}} = V_{\text{GE2}} = 15\text{V}, R_G = 6.3\Omega$	-	-	100	ns
Load	Rise Time		-	-	200	ns
Switch Times	Turn-off Delay Time		-	-	200	ns
	Fall Time		-	-	400	ns
Diode Reverse Recovery Time	$t_{\text{rr}}$	$I_E = 50\text{A}, di_E/dt = -100\text{A}/\mu\text{s}$	-	-	300	ns
Diode Reverse Recovery Charge	$Q_{\text{rr}}$	$I_E = 50\text{A}, di_E/dt = -100\text{A}/\mu\text{s}$	-	1.1	-	$\mu\text{C}$

**Thermal and Mechanical Characteristics,  $T_J = 25^\circ\text{C}$  unless otherwise specified**

Characteristics	Symbol	Test Conditions	Min.	Typ.	Max.	Units
Thermal Resistance, Junction to Case	$R_{\text{th(j-c)}}$	Per IGBT	-	-	0.31	$^\circ\text{C}/\text{W}$
Thermal Resistance, Junction to Case	$R_{\text{th(j-c)}}$	Per Free Wheel Diode	-	-	0.70	$^\circ\text{C}/\text{W}$
Contact Thermal Resistance	$R_{\text{th(c-f)}}$	Per Half Module	-	-	0.15	$^\circ\text{C}/\text{W}$



Powerex, Inc., 200 Hillis Street, Youngwood, Pennsylvania 15697-1800 (412) 925-7272

**CM50E3Y-24E**  
**Chopper IGBTMOD™ E-Series Module**  
**50 Amperes/1200 Volts**

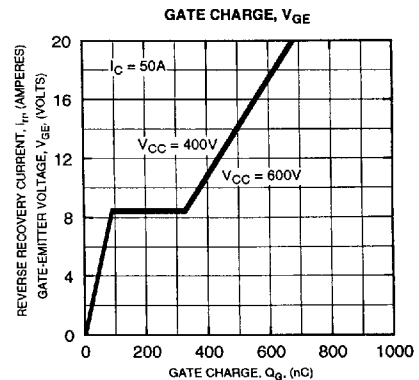
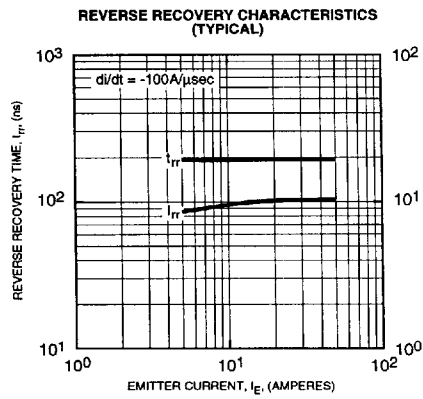
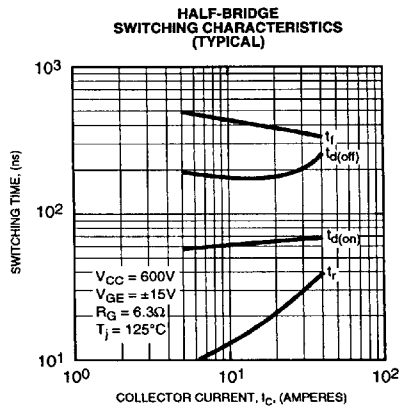
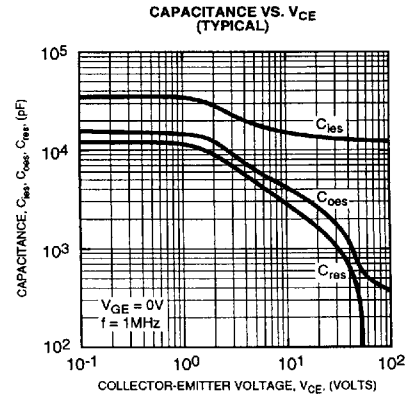
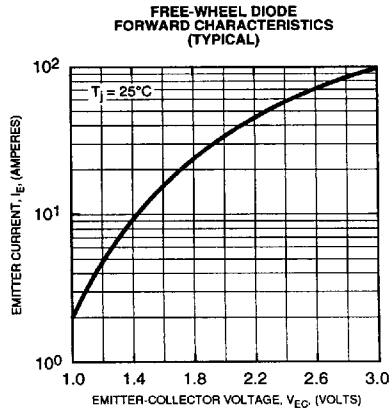
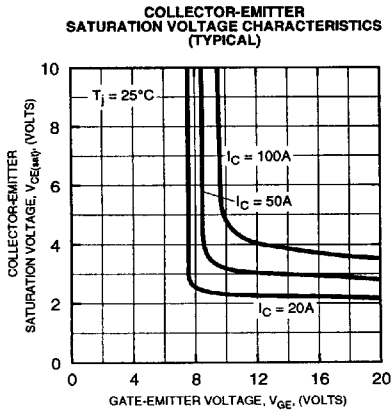
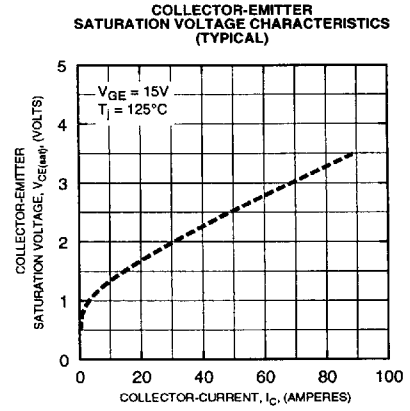
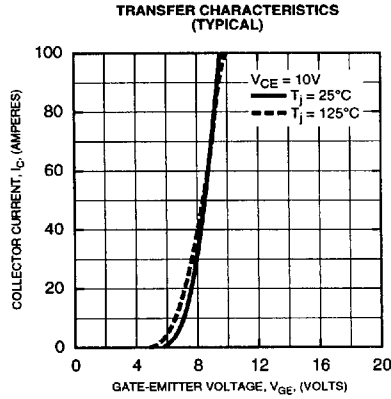
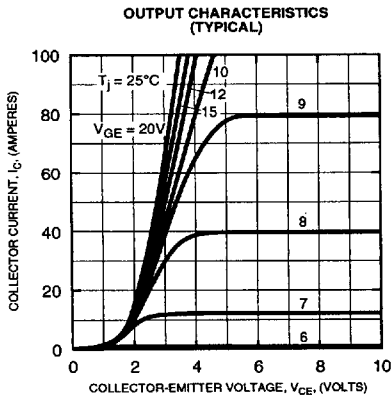

7294621 0007265 451

**CM50E3Y-24E**  
**Chopper IGBTMOD™ E-Series Module**  
 50 Amperes/1200 Volts

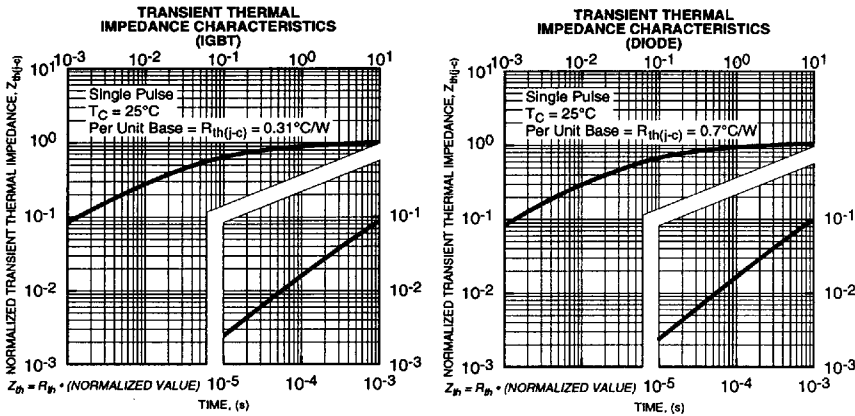

### SWITCHING TIME TEST CIRCUITS & WAVEFORMS

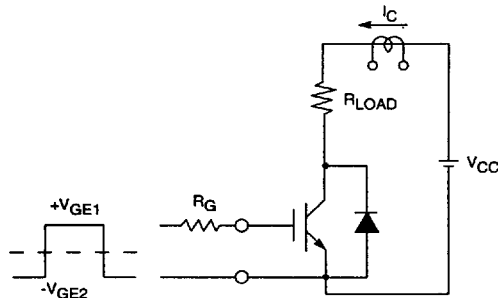

RESISTANCE LOAD SWITCHING TEST CIRCUIT

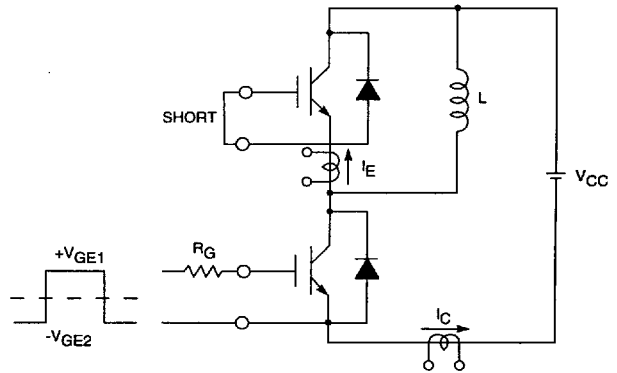

HALF-BRIDGE SWITCHING TEST CIRCUIT

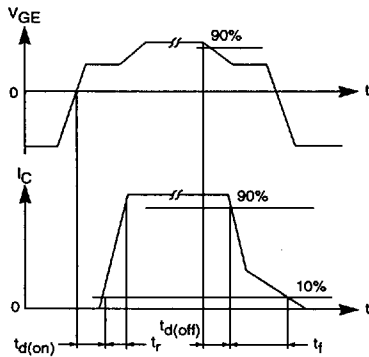

SWITCHING TIME TEST WAVEFORMS

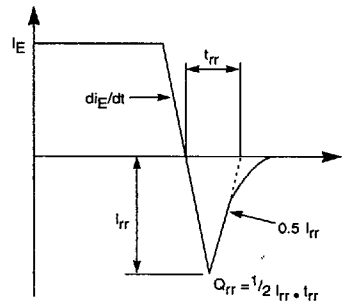

$t_{rr}, Q_{rr}$  WAVEFORMS