

MITSUBISHI IGBT MODULES
CM450HA-5F
 HIGH POWER SWITCHING USE
 INSULATED TYPE

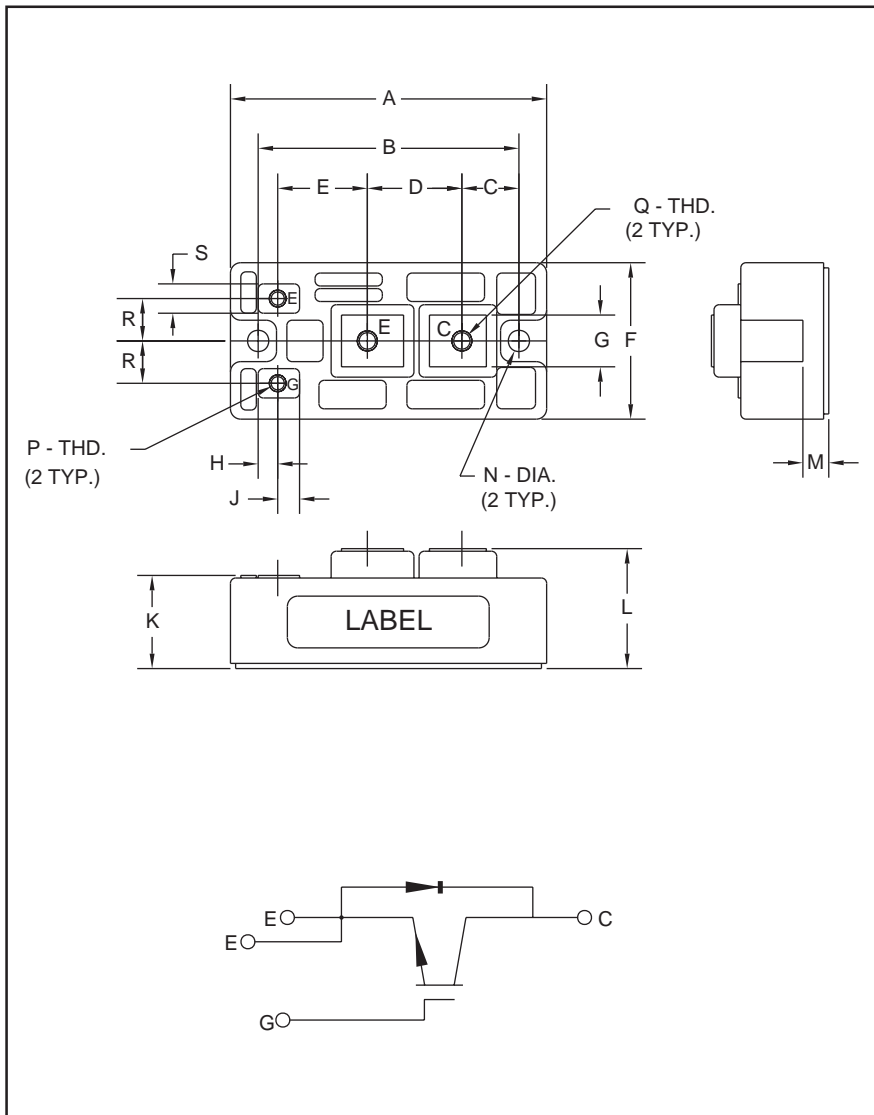

Outline Drawing and Circuit Diagram



Description:

Mitsubishi IGBT Modules are designed for use in switching applications. Each module consists of one IGBT in a single configuration, with a reverse connected super-fast recovery free-wheel diode. All components and interconnects are isolated from the heat sinking baseplate, offering simplified system assembly and thermal management.

Features:

- Low Drive Power
- Low $V_{CE(sat)}$
- Discrete Super-Fast Recovery Free-Wheel Diodes
- High Frequency Operation
- Isolated Baseplate for Easy Heat Sinking

Applications:

- UPS
- Forklift

Ordering Information:

Example: Select the complete nine digit module part number you desire from the table below - i.e. CM450HA-5F is a 250V (V_{CES}), 450 Ampere Single IGBT Module.

Type	Current Rating Amperes	V_{CES} Volts (x 50)
CM	450	5

Dimensions	Inches	Millimeters
A	3.82	97.0
B	3.15	80.0
C	0.69	17.5
D	1.14	29.0
E	1.04	26.5
F	1.89	48.0
G	0.63	16.0
H	0.24	6.0
J	0.26	6.7

Dimensions	Inches	Millimeters
K	1.14	29.0 ^{+1.0} _{-0.5}
L	1.42	36.0 ^{+1.0} _{-0.5}
M	0.28	7.0
N	0.26 Dia.	Dia. 6.5
P	M4 Metric	M4
Q	M6 Metric	M6
R	0.51	13.0
S	0.35	9.0

CM450HA-5F

HIGH POWER SWITCHING USE
INSULATED TYPE

Absolute Maximum Ratings, $T_j = 25^\circ\text{C}$ unless otherwise specified

	Symbol	Ratings	Units
Junction Temperature	T_j	-40 to 150	$^\circ\text{C}$
Storage Temperature	T_{stg}	-40 to 125	$^\circ\text{C}$
Collector-Emitter Voltage (G-E Short)	V_{CES}	250	Volts
Gate-Emitter Voltage (C-E Short)	V_{GES}	± 20	Volts
Collector Current ($T_C = 25^\circ\text{C}$)	I_C	450	Amperes
Peak Collector Current ($T_j \leq 150^\circ\text{C}$)	I_{CM}	900*	Amperes
Emitter Current** ($T_C = 25^\circ\text{C}$)	I_E	450	Amperes
Peak Emitter Current**	I_{EM}	900*	Amperes
Maximum Collector Dissipation ($T_C = 25^\circ\text{C}$)	P_C	735	Watts
Mounting Torque, M6 Main Terminal	—	1.96 ~ 2.94	N · m
Mounting Torque, M6 Mounting	—	1.96 ~ 2.94	N · m
Mounting Torque, M4 Terminal	—	0.98 ~ 1.47	N · m
Weight	—	270	Grams
Isolation Voltage (Main Terminal to Baseplate, AC 1 min.)	V_{iso}	2500	V_{rms}

*Pulse width and repetition rate should be such that the device junction temperature (T_j) does not exceed $T_{j(\text{max})}$ rating.

**Represents characteristics of the anti-parallel, emitter-to-collector free-wheel diode (FWDi).

Static Electrical Characteristics, $T_j = 25^\circ\text{C}$ unless otherwise specified

Characteristics	Symbol	Test Conditions	Min.	Typ.	Max.	Units
Collector-Cutoff Current	I_{CES}	$V_{\text{CE}} = V_{\text{CES}}, V_{\text{GE}} = 0\text{V}$	—	—	1.0	mA
Gate Leakage Current	I_{GES}	$V_{\text{GE}} = V_{\text{GES}}, V_{\text{CE}} = 0\text{V}$	—	—	0.5	μA
Gate-Emitter Threshold Voltage	$V_{\text{GE(th)}}$	$I_C = 45\text{mA}, V_{\text{CE}} = 10\text{V}$	3.0	4.0	5.0	Volts
Collector-Emitter Saturation Voltage	$V_{\text{CE(sat)}}$	$I_C = 450\text{A}, V_{\text{GE}} = 10\text{V},$	—	1.2	1.7**	Volts
		$I_C = 450\text{A}, V_{\text{GE}} = 10\text{V}, T_j = 150^\circ\text{C}$	—	1.1	—	Volts
Total Gate Charge	Q_G	$V_{\text{CC}} = 100\text{V}, I_C = 450\text{A}, V_{\text{GE}} = 10\text{V}$	—	1760	—	nC
Emitter-Collector Voltage	V_{EC}	$I_E = 450\text{A}, V_{\text{GE}} = 0\text{V}$	—	—	2.0	Volts

** Pulse width and repetition rate should be such that device junction temperature rise is negligible.

Dynamic Electrical Characteristics, $T_j = 25^\circ\text{C}$ unless otherwise specified

Characteristics	Symbol	Test Conditions	Min.	Typ.	Max.	Units
Input Capacitance	C_{ies}		—	—	132	nF
Output Capacitance	C_{oes}	$V_{\text{GE}} = 0\text{V}, V_{\text{CE}} = 10\text{V}$	—	—	6	nF
Reverse Transfer Capacitance	C_{res}		—	—	4.5	nF
Resistive	Turn-on Delay Time	$t_{\text{d(on)}}$	—	—	1200	ns
	Rise Time	t_r	—	—	2700	ns
Switching	Turn-off Delay Time	$t_{\text{d(off)}}$	—	—	900	ns
	Fall Time	t_f	—	—	500	ns
Diode Reverse Recovery Time	t_{rr}	$I_E = 450\text{A}, di_E/dt = -900\text{A}/\mu\text{s}$	—	—	300	ns
Diode Reverse Recovery Charge	Q_{rr}	$I_E = 450\text{A}, di_E/dt = -900\text{A}/\mu\text{s}$	—	7.6	—	μC

Thermal and Mechanical Electrical Characteristics, $T_j = 25^\circ\text{C}$ unless otherwise specified

Characteristics	Symbol	Test Conditions	Min.	Typ.	Max.	Units
Thermal Resistance, Junction to Case	$R_{\text{th(j-c)}}$	Per IGBT	—	—	0.17	$^\circ\text{C}/\text{W}$
Thermal Resistance, Junction to Case	$R_{\text{th(j-c)}}$	Per Free Wheel Diode	—	—	0.23	$^\circ\text{C}/\text{W}$
Contact Thermal Resistance	$R_{\text{th(c-f)}}$	Per Module, Thermal Grease Applied	—	—	0.090	$^\circ\text{C}/\text{W}$

CM450HA-5F

HIGH POWER SWITCHING USE
INSULATED TYPE

OUTPUT CHARACTERISTICS
(TYPICAL)

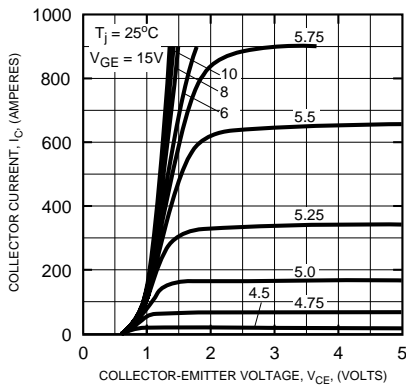

TRANSFER CHARACTERISTICS
(TYPICAL)

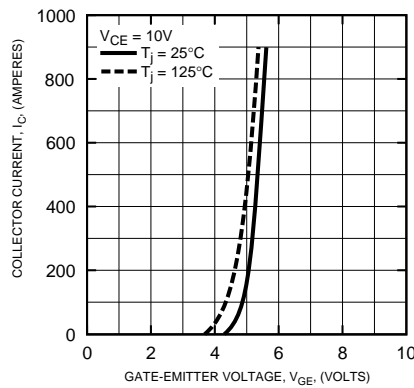

COLLECTOR-EMITTER SATURATION VOLTAGE CHARACTERISTICS
(TYPICAL)

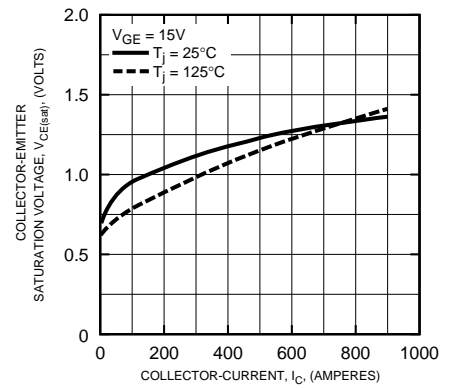

COLLECTOR-EMITTER SATURATION VOLTAGE CHARACTERISTICS
(TYPICAL)

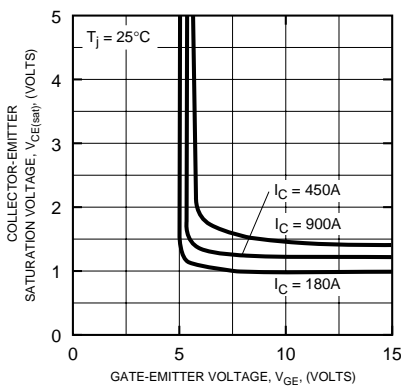

FREE-WHEEL DIODE FORWARD CHARACTERISTICS
(TYPICAL)

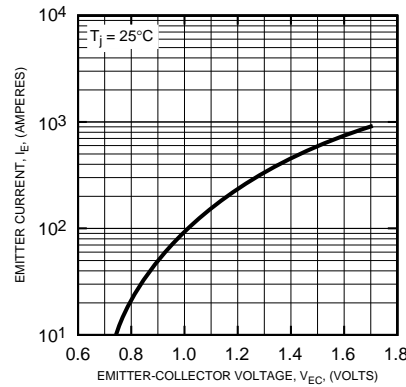

CAPACITANCE VS. V_{CE}
(TYPICAL)

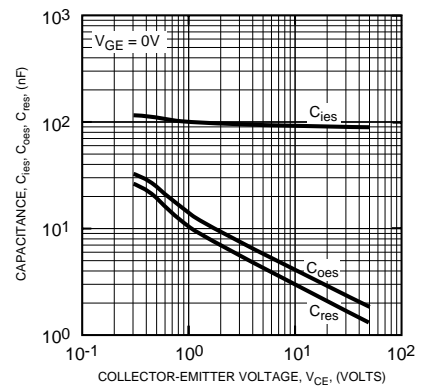

HALF-BRIDGE SWITCHING CHARACTERISTICS
(TYPICAL)

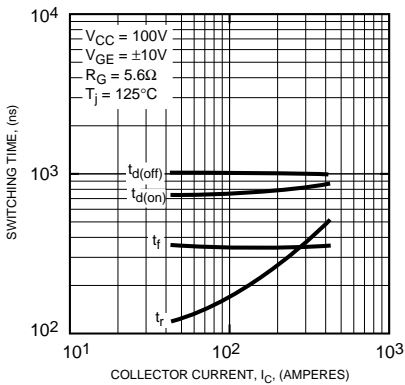

REVERSE RECOVERY CHARACTERISTICS
(TYPICAL)

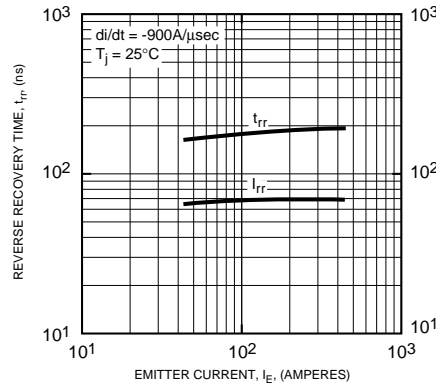

GATE CHARGE, V_{GE}

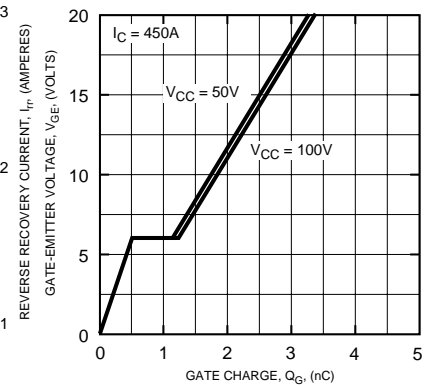

CM450HA-5F

HIGH POWER SWITCHING USE
INSULATED TYPE

TRANSIENT THERMAL
IMPEDANCE CHARACTERISTICS
(IGBT)

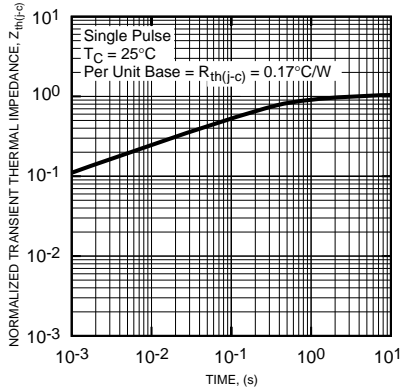

TRANSIENT THERMAL
IMPEDANCE CHARACTERISTICS
(FWDi)

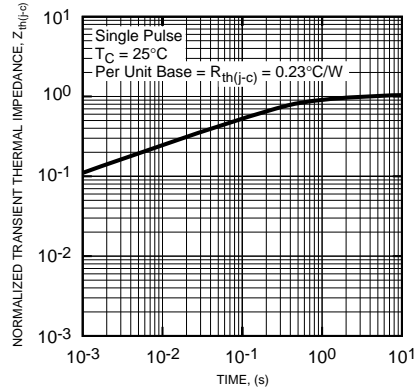

Important Notice

The information contained in this datasheet shall in no event be regarded as a guarantee of conditions or characteristics. This product has to be used within its specified maximum ratings, and is subject to customer's compliance with any applicable legal requirement, norms and standards.

Except as otherwise explicitly approved by Mitsubishi Electric Corporation in a written document signed by authorized representatives of Mitsubishi Electric Corporation, our products may not be used in any applications where a failure of the product or any consequences of the use thereof can reasonably be expected to result in personal injury.

In usage of power semiconductor, there is always the possibility that trouble may occur with them by the reliability lifetime such as Power Cycle, Thermal Cycle or others, or when used under special circumstances (e.g. condensation, high humidity, dusty, salty, highlands, environment with lots of organic matter / corrosive gas / explosive gas, or situations which terminals of semiconductor products receive strong mechanical stress). Therefore, please pay sufficient attention to such circumstances. Further, depending on the technical requirements, our semiconductor products may contain environmental regulation substances, etc. If there is necessity of detailed confirmation, please contact our nearest sales branch or distributor.

The contents or data contained in this datasheet are exclusively intended for technically trained staff. Customer's technical departments should take responsibility to evaluate the suitability of Mitsubishi Electric Corporation product for the intended application and the completeness of the product data with respect to such application. In the customer's research and development, please evaluate it not only with a single semiconductor product but also in the entire system, and judge whether it's applicable. As required, pay close attention to the safety design by installing appropriate fuse or circuit breaker between a power supply and semiconductor products to prevent secondary damage. Please also pay attention to the application note and the related technical information.

Keep safety first in your circuit designs!

Mitsubishi Electric Corporation puts the maximum effort into making semiconductor products better and more reliable, but there is always the possibility that trouble may occur with them. Trouble with semiconductors may lead to personal injury, fire or property damage. Remember to give due consideration to safety when making your circuit designs, with appropriate measures such as (i) placement of substitutive, auxiliary circuits, (ii) use of non-flammable material or (iii) prevention against any malfunction or mishap.

Notes regarding these materials

- These materials are intended as a reference to assist our customers in the selection of the Mitsubishi Electric Semiconductor product best suited to the customer's application; they do not convey any license under any intellectual property rights, or any other rights, belonging to Mitsubishi Electric Corporation or a third party.
- Mitsubishi Electric Corporation assumes no responsibility for any damage, or infringement of any third-party's rights, originating in the use of any product data, diagrams, charts, programs, algorithms, or circuit application examples contained in these materials.
- All information contained in these materials, including product data, diagrams, charts, programs and algorithms represents information on products at the time of publication of these materials, and are subject to change by Mitsubishi Electric Corporation without notice due to product improvements or other reasons. It is therefore recommended that customers contact Mitsubishi Electric Corporation or an authorized Mitsubishi Electric Semiconductor product distributor for the latest product information before purchasing a product listed herein.
The information described here may contain technical inaccuracies or typographical errors. Mitsubishi Electric Corporation assumes no responsibility for any damage, liability, or other loss rising from these inaccuracies or errors.
Please also pay attention to information published by Mitsubishi Electric Corporation by various means, including the Mitsubishi Electric Semiconductor home page (<http://www.MitsubishiElectric.com/semiconductors/>).
- When using any or all of the information contained in these materials, including product data, diagrams, charts, programs, and algorithms, please be sure to evaluate all information as a total system before making a final decision on the applicability of the information and products. Mitsubishi Electric Corporation assumes no responsibility for any damage, liability or other loss resulting from the information contained herein.
- Mitsubishi Electric Corporation semiconductors are not designed or manufactured for use in a device or system that is used under circumstances in which human life is potentially at stake. Please contact Mitsubishi Electric Corporation or an authorized Mitsubishi Electric Semiconductor product distributor when considering the use of a product contained herein for any specific purposes, such as apparatus or systems for transportation, vehicular, medical, aerospace, nuclear, or undersea repeater use.
- The prior written approval of Mitsubishi Electric Corporation is necessary to reprint or reproduce in whole or in part these materials.
- If these products or technologies are subject to the Japanese export control restrictions, they must be exported under a license from the Japanese government and cannot be imported into a country other than the approved destination.
Any diversion or re-export contrary to the export control laws and regulations of Japan and/or the country of destination is prohibited.
- Please contact Mitsubishi Electric Corporation or an authorized Mitsubishi Electric Semiconductor product distributor for further details on these materials or the products contained therein.

Generally the listed company name and the brand name are the trademarks or registered trademarks of the respective companies.