

**SCR/Diode  
POW-R-BLOK™ Modules  
90 Amperes/1200-1600 Volts**

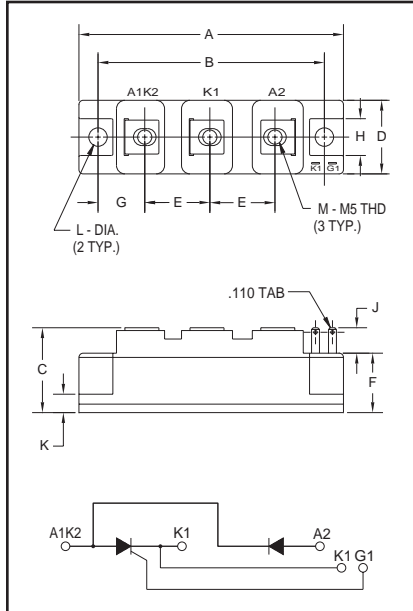

**Outline Drawing**

Dimension	Inches	Millimeters
A	3.681 Max.	93.5 Max.
B	3.150	80
C	1.181 Max.	30 Max.
D	1.024 Max.	26 Max.
E	0.906	23
F	0.827	21
G	0.650	16.5
H	0.512	13
J	0.354	9
K	0.256	6.5
L	0.256 Dia.	Dia. 6.5
M	M5 Metric	M5



**CM421290, CM421690  
SCR/Diode  
POW-R-BLOK™ Modules  
90 Amperes/1200-1600 Volts**

**Description:**

Powerex SCR/Diode POW-R-BLOK™ Modules are designed for use in applications requiring Half-Control and isolated packaging. The modules are isolated for easy mounting with other components on common heatsinks.

**Features:**

- Isolated Mounting
- Glass Passivated Chips
- Metal Baseplate
- Low Thermal Impedance

**Applications:**

- Battery Supplies
- Bridge Circuits
- AC and DC Motor Control
- Tap Changers
- Lighting Control

**Ordering Information:**

Select the complete eight digit module part number you desire from the table below. Example: CM421290 is a 1200 Volt, 90 Ampere SCR/Diode POW-R-BLOK™ Module.

Type	Voltage Volts (x100)	Current Rating Amperes (90)
CM42	12 16	90



Powerex, Inc., 200 Hillis Street, Youngwood, Pennsylvania 15697-1800 (724) 925-7272

CM421290, CM421690  
SCR/Diode POW-R-BLOK™ Modules  
90 Amperes/1200-1600 Volts

### Absolute Maximum Ratings

Characteristics	Symbol	CM421290	CM421690	Units
Peak Forward Blocking Voltage	$V_{DRM}$	1200	1600	Volts
Transient Peak Forward Blocking Voltage (Non-Repetitive), $t < 5ms$	$V_{DSM}$	1350	1700	Volts
DC Forward Blocking Voltage	$V_{D(DC)}$	960	1280	Volts
Peak Reverse Blocking Voltage	$V_{RRM}$	1200	1600	Volts
Transient Peak Reverse Blocking Voltage (Non-Repetitive), $t < 5ms$	$V_{RSM}$	1350	1700	Volts
DC Reverse Blocking Voltage	$V_{R(DC)}$	960	1280	Volts
RMS On-State Current	$I_{T(RMS)}, I_{F(RMS)}$	140	140	Amperes
Average On-State Current, $T_C = 82^\circ C$	$I_{T(AV)}, I_{F(AV)}$	90	90	Amperes
Peak One-Cycle Surge (Non-Repetitive) On-State Current (60Hz)	$I_{TSM}, I_{FSM}$	1800	1800	Amperes
Peak One-Cycle Surge (Non-Repetitive) On-State Current (50Hz)	$I_{TSM}, I_{FSM}$	1730	1730	Amperes
$I^2t$ (for Fusing), 8.3 milliseconds	$I^2t$	15000	15000	$A^2sec$
Critical Rate-of-Rise of On-State Current*	$di/dt$	100	100	Amperes/ $\mu s$
Peak Gate Power Dissipation	$P_{GM}$	5.0	5.0	Watts
Average Gate Power Dissipation	$P_{G(AV)}$	0.5	0.5	Watts
Peak Forward Gate Voltage	$V_{GFM}$	10	10	Volts
Peak Reverse Gate Voltage	$V_{GRM}$	5.0	5.0	Volts
Peak Forward Gate Current	$I_{GFM}$	2.0	2.0	Amperes
Storage Temperature	$T_{STG}$	-40 to 125	-40 to 125	$^\circ C$
Operating Temperature	$T_j$	-40 to 125	-40 to 125	$^\circ C$
Maximum Mounting Torque M6 Mounting Screw	—	26	26	in.-lb.
Maximum Mounting Torque M5 Terminal Screw	—	17	17	in.-lb.
Module Weight (Typical)	—	160	160	Grams
V Isolation	$V_{RMS}$	2500	2500	Volts

\* $T_j = 125^\circ C, I_G = 1.0A, V_D = 1/2 V_{DRM}$

### Electrical and Thermal Characteristics, $T_j = 25^\circ C$ unless otherwise specified

Characteristics	Symbol	Test Conditions	CM421290/CM421690	Units
<b>Blocking State Maximums</b>				
Forward Leakage Current, Peak	$I_{DRM}$	$T_j = 125^\circ C, V_{DRM} = \text{Rated}$	15	mA
Reverse Leakage Current, Peak	$I_{RRM}$	$T_j = 125^\circ C, V_{RRM} = \text{Rated}$	15	mA
<b>Conducting State Maximums</b>				
Peak On-State Voltage	$V_{FM}, V_{TM}$	$I_{FM} = 270A, I_{TM} = 270A$	1.4	Volts
<b>Switching Minimums</b>				
Critical Rate-of-Rise of Off-State Voltage	$dv/dt$	$T_j = 125^\circ C, V_D = 2/3 V_{DRM}$	500	Volts/ $\mu s$
<b>Thermal Maximums</b>				
Thermal Resistance, Junction-to-Case	$R_{\theta(J-C)}$	Per Module	0.3	$^\circ C/Watt$
Thermal Resistance, Case-to-Sink (Lubricated)	$R_{\theta(C-S)}$	Per Module	0.2	$^\circ C/Watt$
<b>Gate Parameters Maximums</b>				
Gate Current-to-Trigger	$I_{GT}$	$V_D = 6V, R_L = 2\Omega$	100	mA
Gate Voltage-to-Trigger	$V_{GT}$	$V_D = 6V, R_L = 2\Omega$	2.0	Volts
Non-Triggering Gate Voltage	$V_{GDM}$	$T_j = 125^\circ C, V_D = 1/2 V_{DRM}$	0.25	Volts

**CM421290, CM421690**  
**SCR/Diode POW-R-BLOK™ Modules**  
 90 Amperes/1200-1600 Volts

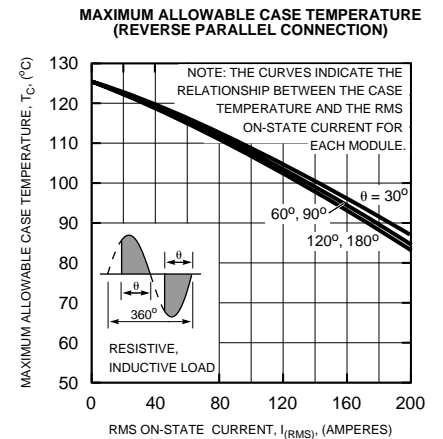
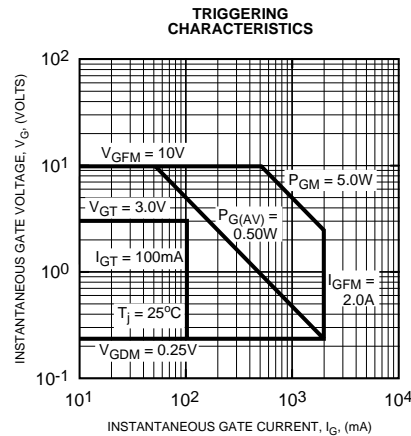
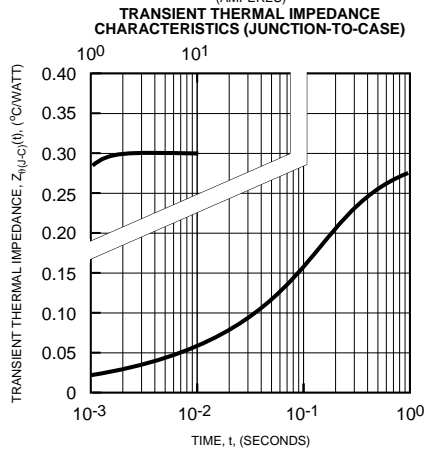
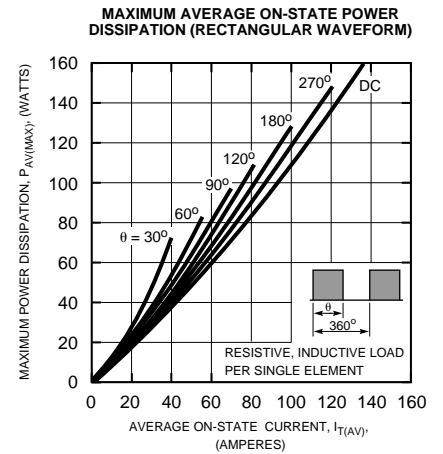
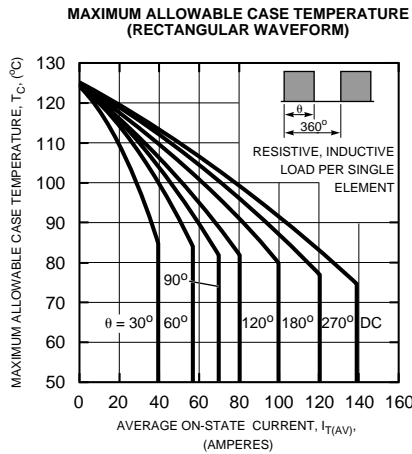
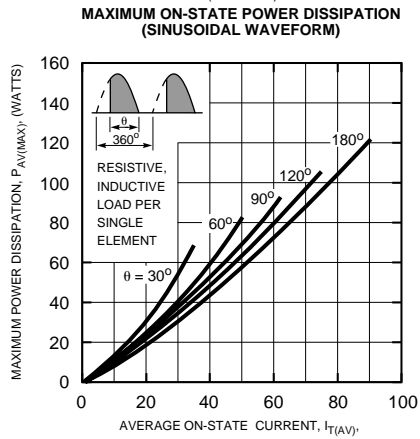
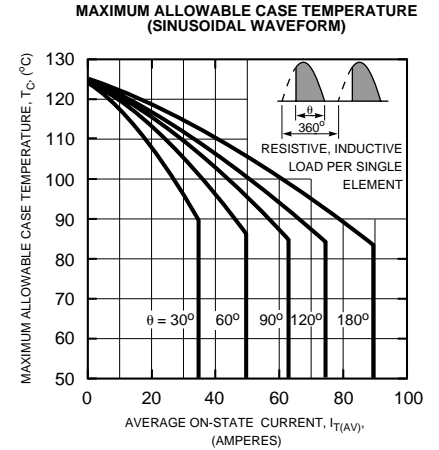
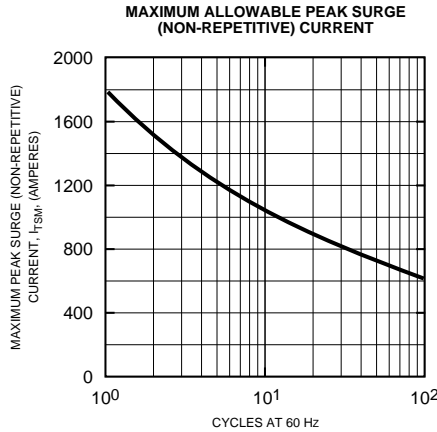
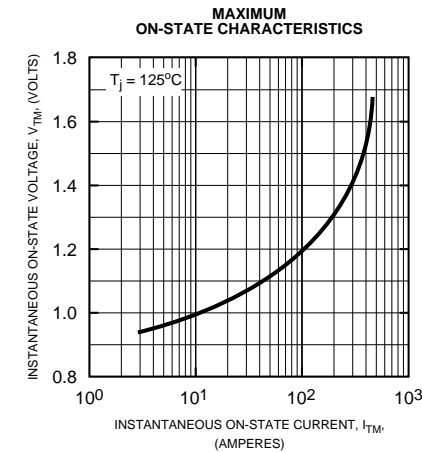

**CM421290, CM421690**  
**SCR/Diode POW-R-BLOK™ Modules**  
 90 Amperes/1200-1600 Volts

**MAXIMUM ON-STATE POWER DISSIPATION (REVERSE PARALLEL CONNECTION)**

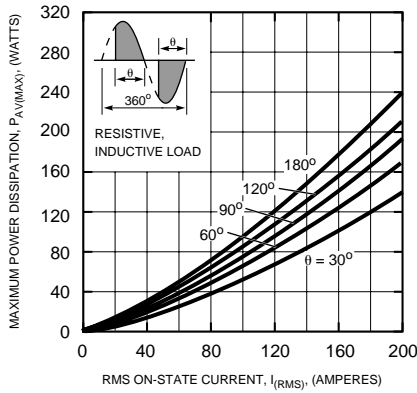

NOTE: THE CURVES INDICATE THE RELATIONSHIP BETWEEN THE AVERAGE ON-STATE POWER DISSIPATION PER MODULE AND THE RMS ON-STATE CURRENT.

**MAXIMUM ALLOWABLE CASE TEMPERATURE (SINGLE PHASE BRIDGE CONNECTION)**

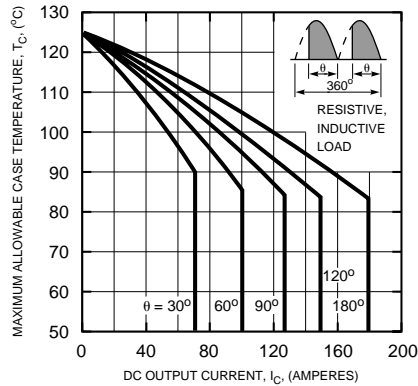

NOTE: THE CURVES INDICATE THE RELATIONSHIP BETWEEN THE CASE TEMPERATURE AND THE DC OUTPUT CURRENT (FOR TWO ELEMENTS) WHEN USED IN THE SINGLE PHASE BRIDGE CONFIGURATION.

**MAXIMUM ON-STATE POWER DISSIPATION (SINGLE PHASE BRIDGE CONNECTION)**

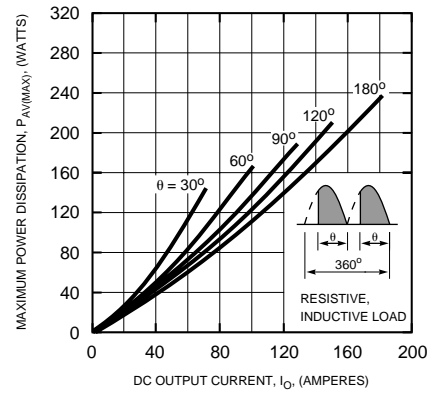

NOTE: THE CURVES INDICATE THE RELATIONSHIP BETWEEN THE AVERAGE ON-STATE POWER DISSIPATION AND THE DC OUTPUT CURRENT FOR THE SINGLE PHASE BRIDGE CONFIGURATION (POWER DISSIPATION EXPRESSED FOR EACH MODULE AND DC OUTPUT CURRENT EXPRESSED FOR THE PAIR)

**MAXIMUM ALLOWABLE CASE TEMPERATURE (THREE PHASE BRIDGE CONNECTION)**

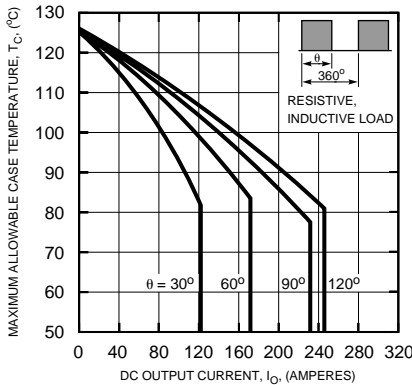

NOTE: THE CURVES INDICATE THE RELATIONSHIP BETWEEN THE CASE TEMPERATURE AND THE DC OUTPUT CURRENT (FOR THREE MODULES) IN THE THREE PHASE CONFIGURATION.

**MAXIMUM ON-STATE POWER DISSIPATION (THREE PHASE BRIDGE CONNECTION)**

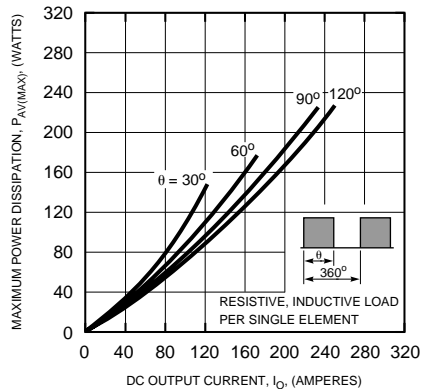

NOTE: THE CURVES INDICATE THE RELATIONSHIP BETWEEN THE ON-STATE POWER DISSIPATION (PER MODULE) AND THE DC OUTPUT CURRENT (FOR THREE MODULES) IN THE THREE PHASE BRIDGE CONFIGURATION.