

MITSUBISHI IGBT MODULES  
**CM30MD1-12H**  
 MEDIUM POWER SWITCHING USE  
 FLAT-BASE TYPE, INSULATED TYPE

**CM30MD1-12H**

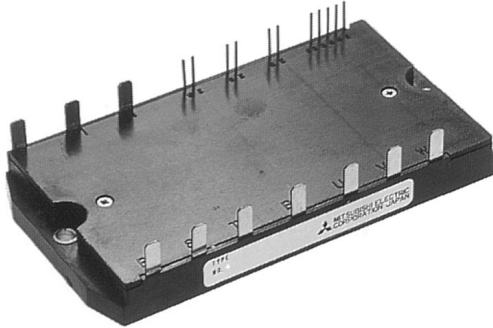

- IC ..... 30A
- VCES ..... 600V
- Insulated Type
- CIB Module
- 3φ Inverter+3φ Converter
- UL Recognized

Yellow Card No. E80276 (N)  
 File No. E80271

**APPLICATION**

AC & DC motor controls, General purpose inverters, Servo controls, NC, Robotics, UPS

**OUTLINE DRAWING & CIRCUIT DIAGRAM**

Dimensions in mm

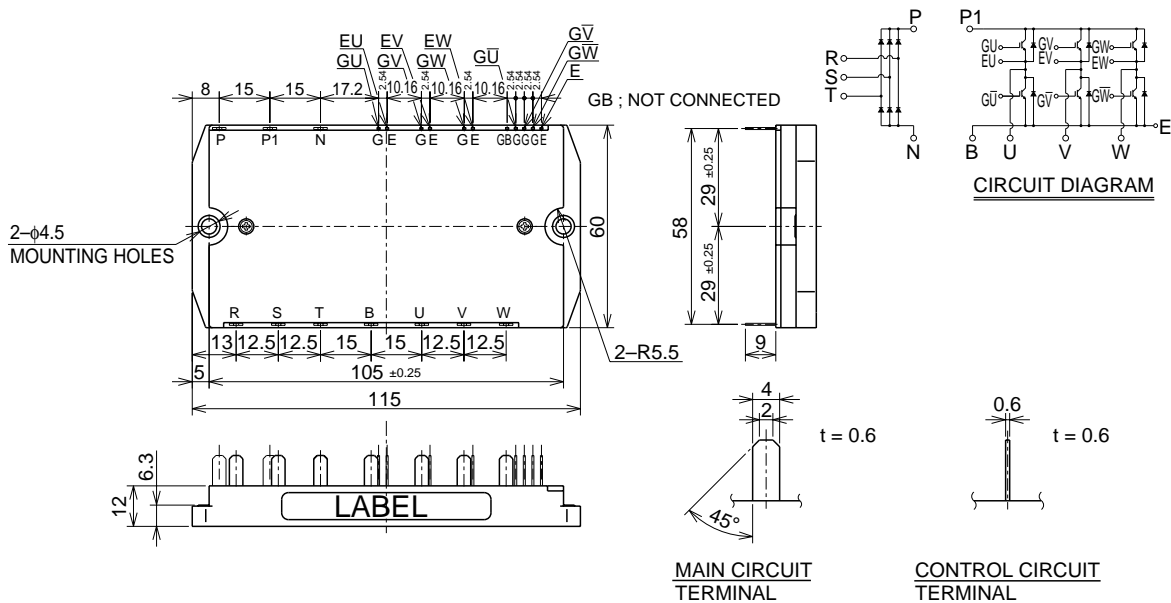

## CM30MD1-12H

MEDIUM POWER SWITCHING USE  
FLAT-BASE TYPE, INSULATED TYPE**MAXIMUM RATINGS** ( $T_j = 25^\circ\text{C}$ )  
**INVERTER PART**

Symbol	Parameter	Condition	Rating	Unit
V <sub>CES</sub>	Collector-emitter voltage	G – E Short	600	V
V <sub>GES</sub>	Gate-emitter voltage	C – E Short	±20	V
I <sub>C</sub>	Collector Current	T <sub>C</sub> = 25°C	30	A
I <sub>CM</sub>		PULSE (Note. 2)	60	A
I <sub>E</sub> (Note. 1)	Emitter Current	T <sub>C</sub> = 25°C	30	A
I <sub>EM</sub> (Note. 1)		PULSE (Note. 2)	60	A
P <sub>C</sub> (Note. 3)	Maximum collector dissipation	T <sub>f</sub> = 25°C	66	W

**CONVERTER PART**

Symbol	Parameter	Condition	Rating	Unit
V <sub>RRM</sub>	Repetitive peak reverse voltage		800	V
E <sub>a</sub>	Recommended AC input voltage		220	V
I <sub>O</sub>	DC output current	3 $\phi$ rectifying circuit T <sub>f</sub> = 123°C	30	A
I <sub>FSM</sub>	Surge (non-repetitive) forward current	1 cycle at 60Hz, peak value Non-repetitive	550	A
I <sup>2</sup> t	I <sup>2</sup> t for fusing	Value for one cycle of surge current	1.2X10 <sup>3</sup>	A <sup>2</sup> s

**COMMON RATING**

Symbol	Parameter	Condition	Rating	Unit
T <sub>j</sub>	Junction temperature		-40 ~ +150	°C
T <sub>stg</sub>	Storage temperature		-40 ~ +125	°C
V <sub>iso</sub>	Isolation voltage	AC 1 min.	2500	V
—	Mounting torque	Mounting M4 screw	0.98 ~ 1.47	N · m
—	Weight	Typical value	100	g

## CM30MD1-12H

MEDIUM POWER SWITCHING USE  
FLAT-BASE TYPE, INSULATED TYPEELECTRICAL CHARACTERISTICS (T<sub>j</sub> = 25°C)  
INVERTER PART

Symbol	Parameter	Test conditions	Limits			Unit	
			Min.	Typ.	Max.		
ICES	Collector cutoff current	VCE = VCES, VGE = 0V	—	—	1	mA	
VGE(th)	Gate-emitter threshold voltage	IC = 3mA, VCE = 10V	4.5	6	7.5	V	
IGES	Gate-emitter cutoff current	VGE = VGES, VCE = 0V	—	—	0.5	μA	
VCE(sat)	Collector-emitter saturation voltage	IC = 30A, VGE = 15V (Note. 4)	T <sub>j</sub> = 25°C	—	2.1	2.8	V
			T <sub>j</sub> = 150°C	—	2.15	—	
Cies	Input capacitance	VCE = 10V VGE = 0V	—	—	3.0	nF	
Coes	Output capacitance		—	—	2.4	nF	
Cres	Reverse transfer capacitance		—	—	0.6	nF	
QG	Total gate charge	VCC = 300V, IC = 30A, VGE = 15V	—	90	—	nC	
td (on)	Turn-on delay time	VCC = 300V, IC = 30A	—	—	120	ns	
tr	Turn-on rise time	VGE1 = VGE2 = 15V	—	—	300	ns	
td (off)	Turn-off delay time	RG = 21Ω	—	—	200	ns	
tf	Turn-off fall time	Resistive load	—	—	300	ns	
VEC (Note. 1)	Emitter-collector voltage	IE = 30A, VGE = 0V	—	—	2.8	V	
trr (Note. 1)	Reverse recovery time	IE = 30A, VGE = 0V	—	—	110	ns	
Qrr (Note. 1)	Reverse recovery charge	die / dt = -60A / μs	—	0.08	—	μC	
R <sub>th(j-Q)</sub> (Note. 5)	Thermal resistance	IGBT part, Per 1/6 module	—	—	1.9	°C/W	
R <sub>th(j-R)</sub> (Note. 5)		FWDi part, Per 1/6 module	—	—	2.4	°C/W	

## CONVERTER PART

Symbol	Parameter	Condition	Limits			Unit
			Min.	Typ.	Max.	
IRRM	Repetitive reverse current	VR = VRRM, T <sub>j</sub> = 150°C	—	—	8	mA
VFM	Forward voltage drop	IF = 30A	—	—	1.5	V
R <sub>th(j-I)</sub> (Note. 5)	Thermal resistance	Per 1/6 module	—	—	1.7	°C/W

- Note 1. IE, VEC, trr, Qrr & die/dt represent characteristics of the anti-parallel, emitter to collector free-wheel diode.  
 2. Pulse width and repetition rate should be such that the device junction temp. (T<sub>j</sub>) does not exceed T<sub>jmax</sub> rating.  
 3. Junction temperature (T<sub>j</sub>) should not increase beyond 150°C.  
 4. Pulse width and repetition rate should be such as to cause negligible temperature rise.  
 5. Thermal resistance is specified under following conditions.  
 • The conductive grease applied, between module and fin.  
 • Al plate is used as fin.

# CM30MD1-12H

MEDIUM POWER SWITCHING USE  
FLAT-BASE TYPE, INSULATED TYPE

## PERFORMANCE CURVES

**OUTPUT CHARACTERISTICS (TYPICAL)**

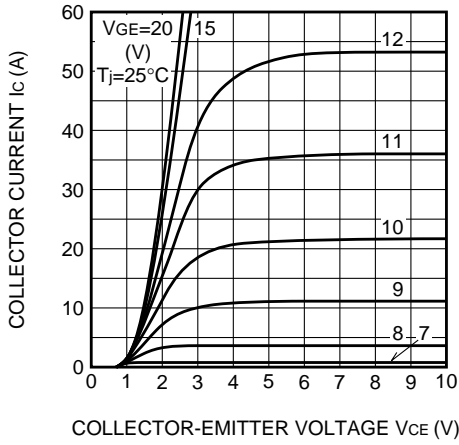

**TRANSFER CHARACTERISTICS (TYPICAL)**

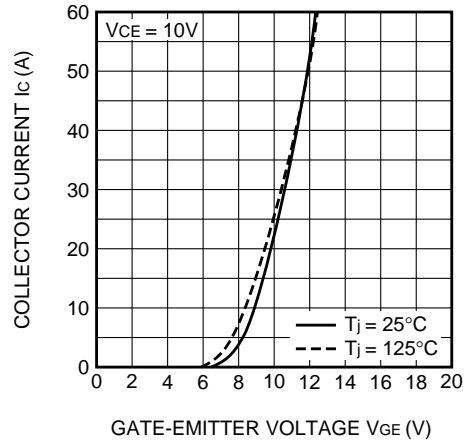

**COLLECTOR-EMITTER SATURATION VOLTAGE CHARACTERISTICS (TYPICAL)**

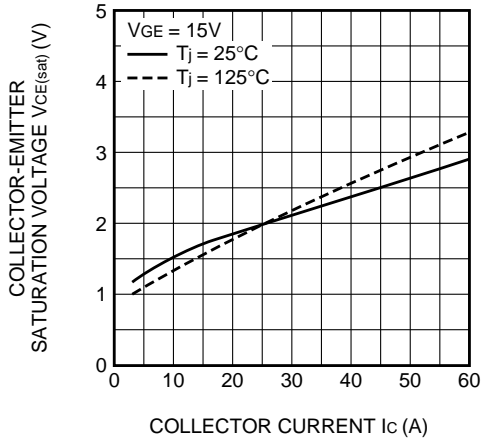

**COLLECTOR-EMITTER SATURATION VOLTAGE CHARACTERISTICS (TYPICAL)**

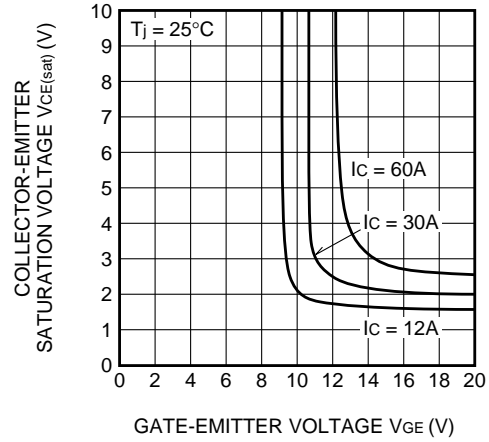

**FREE-WHEEL DIODE FORWARD CHARACTERISTICS (TYPICAL)**

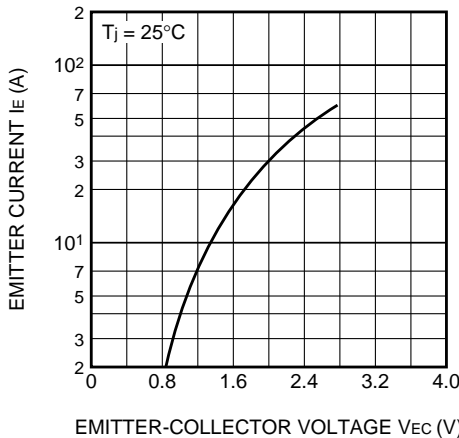

**CAPACITANCE VS. VCE (TYPICAL)**

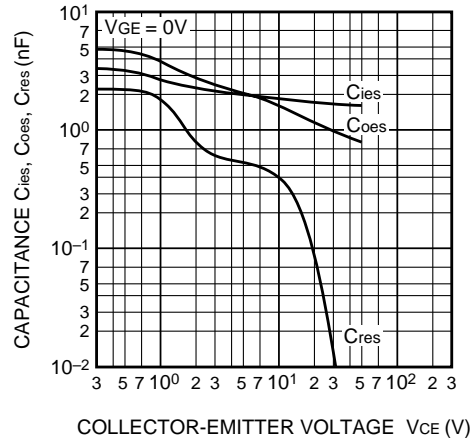

# CM30MD1-12H

MEDIUM POWER SWITCHING USE  
FLAT-BASE TYPE, INSULATED TYPE

**HALF-BRIDGE SWITCHING CHARACTERISTICS (TYPICAL)**

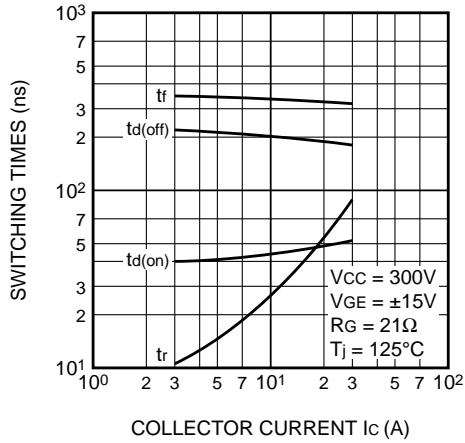

**REVERSE RECOVERY CHARACTERISTICS OF FREE-WHEEL DIODE (TYPICAL)**

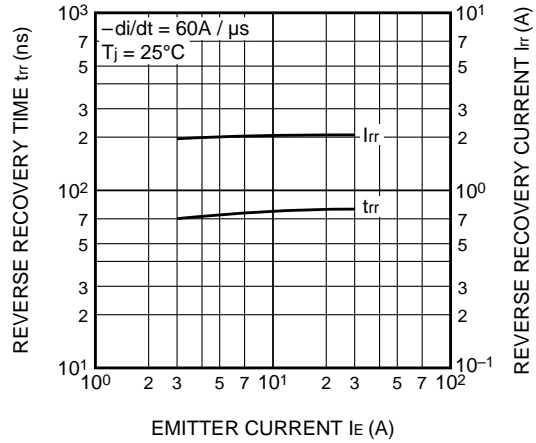

**TRANSIENT THERMAL IMPEDANCE CHARACTERISTICS (IGBT part)**

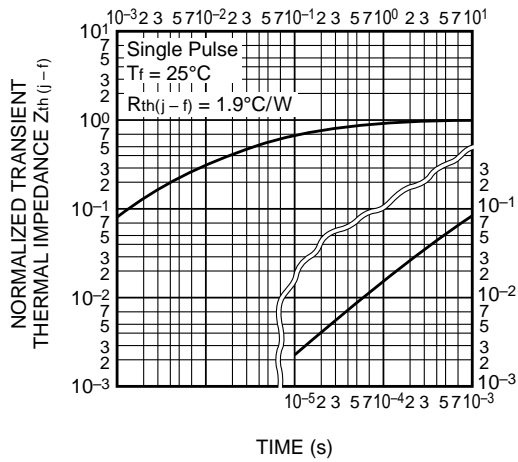

**TRANSIENT THERMAL IMPEDANCE CHARACTERISTICS (FWDi part)**

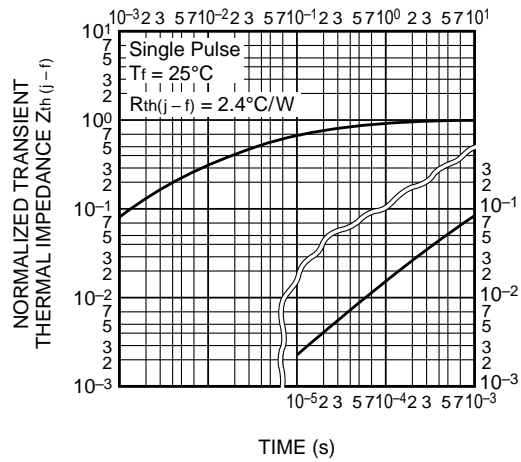

**VGE - GATE CHARGE (TYPICAL)**

