

Chopper IGBTMOD™ U-Series Module 300 Amperes/600 Volts

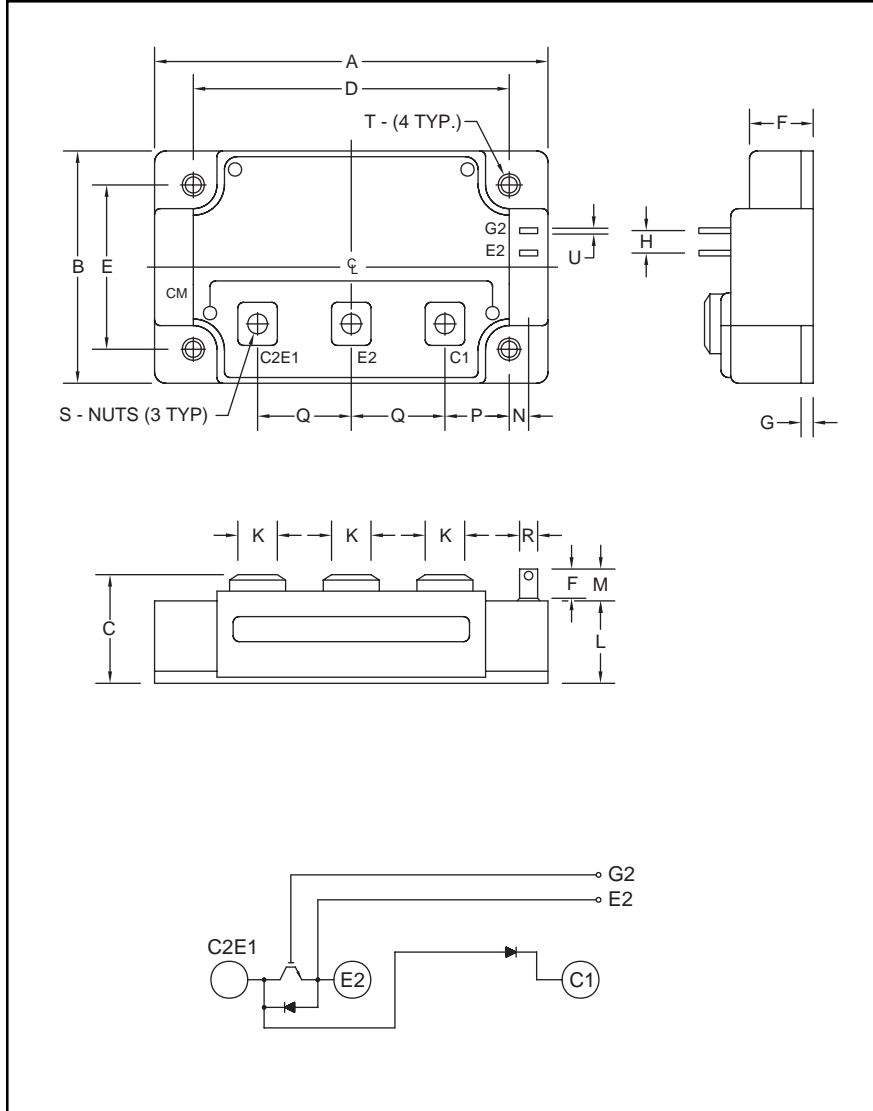

Outline Drawing and Circuit Diagram

Dimensions	Inches	Millimeters
A	4.25	108.0
B	2.44	62.0
C	1.14 +0.04/-0.02	29.0 +1.0/-0.5
D	3.66±0.01	93.0±0.25
E	1.88±0.01	48.0±0.25
F	0.30	7.5
G	0.16	4.0
H	0.24	6.0
J	0.11	2.8
K	0.71	18.0

Dimensions	Inches	Millimeters
L	0.87	22.0
M	0.33	8.5
N	0.10	2.5
P	0.85	21.5
Q	0.98	25.0
R	0.16	4.0
S	M6	M6
T	0.26 Dia.	6.5 Dia.
U	0.02	0.5



Description:

Powerex Chopper IGBTMOD™ Modules are designed for use in switching applications. Each module consists of one IGBT Transistor having a reverse-connected super-fast recovery free-wheel diode and an anode-collector connected super-fast recovery free-wheel diode. All components and interconnects are isolated from the heat sinking baseplate, offering simplified system assembly and thermal management.

Features:

- Low Drive Power
- Low $V_{CE(sat)}$
- Discrete Super-Fast Recovery Free-Wheel Diode
- High Frequency Operation (15-20kHz)
- Isolated Baseplate for Easy Heat Sinking

Applications:

- DC Motor Control
- Boost Regulator

Ordering Information:

Example: Select the complete module number you desire from the table - i.e. CM300E3U-12H is a 600V (V_{CES}), 300 Ampere Chopper IGBTMOD™ Power Module.

Type	Current Rating Amperes	V_{CES} Volts (x 50)
CM	300	12

CM300E3U-12H

Chopper IGBTMOD™ U-Series Module

300 Amperes/600 Volts

Absolute Maximum Ratings, $T_j = 25\text{ }^\circ\text{C}$ unless otherwise specified

Ratings	Symbol	CM300E3U-12H	Units
Junction Temperature	T_j	-40 to 150	$^\circ\text{C}$
Storage Temperature	T_{stg}	-40 to 125	$^\circ\text{C}$
Collector-Emitter Voltage (G-E SHORT)	V_{CES}	600	Volts
Gate-Emitter Voltage (C-E SHORT)	V_{GES}	± 20	Volts
Collector Current ($T_c = 25^\circ\text{C}$)	I_C	300	Amperes
Peak Collector Current ($T_j \leq 150^\circ\text{C}$)	I_{CM}	600*	Amperes
Emitter Current** ($T_c = 25^\circ\text{C}$)	I_E	300	Amperes
Peak Emitter Current**	I_{EM}	600*	Amperes
Maximum Collector Dissipation ($T_c = 25^\circ\text{C}$, $T_j \leq 150^\circ\text{C}$)	P_c	890	Watts
Mounting Torque, M6 Main Terminal	–	40	in-lb
Mounting Torque, M6 Mounting	–	40	in-lb
Weight	–	400	Grams
Isolation Voltage (Main Terminal to Baseplate, AC 1 min.)	V_{iso}	2500	Volts

* Pulse width and repetition rate should be such that the device junction temperature (T_j) does not exceed $T_{j(max)}$ rating.

**Represents characteristics of the anti-parallel, emitter-to-collector free-wheel diode (FWDi).

Static Electrical Characteristics, $T_j = 25\text{ }^\circ\text{C}$ unless otherwise specified

Characteristics	Symbol	Test Conditions	Min.	Typ.	Max.	Units
Collector-Cutoff Current	I_{CES}	$V_{CE} = V_{CES}$, $V_{GE} = 0V$	–	–	1	mA
Gate Leakage Voltage	I_{GES}	$V_{GE} = V_{GES}$, $V_{CE} = 0V$	–	–	0.5	μA
Gate-Emitter Threshold Voltage	$V_{GE(th)}$	$I_C = 30\text{mA}$, $V_{CE} = 10V$	4.5	6	7.5	Volts
Collector-Emitter Saturation Voltage	$V_{CE(sat)}$	$I_C = 300\text{A}$, $V_{GE} = 15V$, $T_j = 25^\circ\text{C}$	–	2.4	3.0	Volts
		$I_C = 300\text{A}$, $V_{GE} = 15V$, $T_j = 125^\circ\text{C}$	–	2.6	–	Volts
Total Gate Charge	Q_G	$V_{CC} = 300V$, $I_C = 300\text{A}$, $V_{GE} = 15V$	–	600	–	nC
Emitter-Collector Voltage**	V_{EC}	$I_E = 300\text{A}$, $V_{GE} = 0V$	–	–	2.6	Volts
Emitter-Collector Voltage	V_{FM}	$I_F = 300\text{A}$, Clamp Diode Part	–	–	2.6	Volts

* Pulse width and repetition rate should be such that the device junction temperature (T_j) does not exceed $T_{j(max)}$ rating.

Dynamic Electrical Characteristics, $T_j = 25\text{ }^\circ\text{C}$ unless otherwise specified

Characteristics	Symbol	Test Conditions	Min.	Typ.	Max.	Units	
Input Capacitance	C_{ies}		–	–	26.4	nf	
Output Capacitance	C_{oes}	$V_{CE} = 10V$, $V_{GE} = 0V$	–	–	14.4	nf	
Reverse Transfer Capacitance	C_{res}		–	–	4	nf	
Resistive	Turn-on Delay Time	$t_{d(on)}$	$V_{CC} = 300V$, $I_C = 300\text{A}$,	–	–	250	ns
Load	Rise Time	t_r	$V_{GE1} = V_{GE2} = 15V$,	–	–	600	ns
Switch	Turn-off Delay Time	$t_{d(off)}$	$R_G = 2.1\Omega$, Resistive	–	–	350	ns
Times	Fall Time	t_f	Load Switching Operation	–	–	300	ns
Diode Reverse Recovery Time**	t_{rr}	$I_E = 300\text{A}$, $di_E/dt = -600\text{A}/\mu\text{s}$	–	–	160	ns	
Diode Reverse Recovery Charge**	Q_{rr}	$I_E = 300\text{A}$, $di_E/dt = -600\text{A}/\mu\text{s}$	–	0.72	–	μC	
Diode Reverse Recovery Time	t_{rr}	$I_F = 300\text{A}$, Clamp Diode Part	–	–	160	ns	
Diode Reverse Recovery Charge	Q_{rr}	$di_F/dt = -600\text{A}/\mu\text{s}$	–	0.72	–	μC	

**Represents characteristics of the anti-parallel, emitter-to-collector free-wheel diode (FWDi).

CM300E3U-12H
Chopper IGBTMOD™ U-Series Module
 300 Amperes/600 Volts

Thermal and Mechanical Characteristics, $T_j = 25\text{ }^\circ\text{C}$ unless otherwise specified

Characteristics	Symbol	Test Conditions	Min.	Typ.	Max.	Units
Thermal Resistance, Junction to Case	$R_{th(j-c)Q}$	Per IGBT	–	–	0.14	$^\circ\text{C/W}$
Thermal Resistance, Junction to Case	$R_{th(j-c)D}$	Per FWDi	–	–	0.24	$^\circ\text{C/W}$
Thermal Resistance, Junction to Case	$R_{th(j-c)}$	Clamp Diode Part	–	–	0.24	$^\circ\text{C/W}$
Contact Thermal Resistance	$R_{th(c-f)}$	Per Module, Thermal Grease Applied	–	0.020	–	$^\circ\text{C/W}$

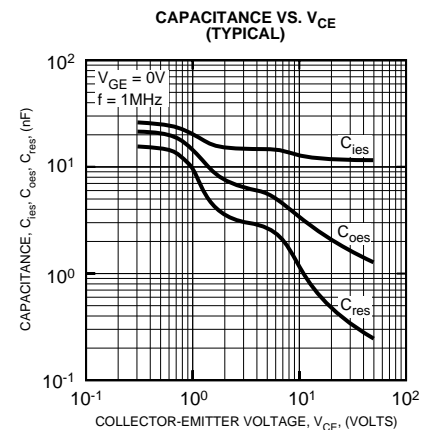
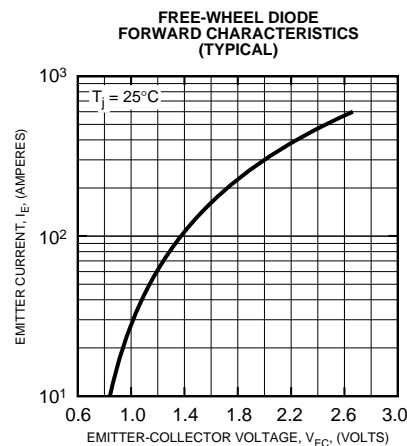
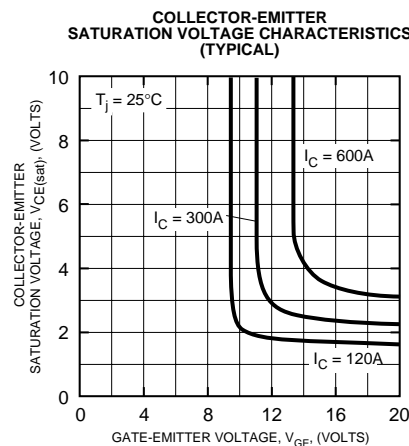
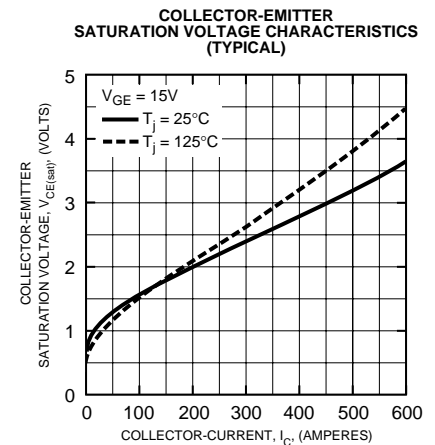
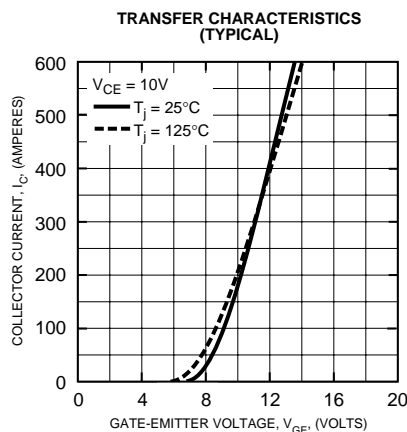
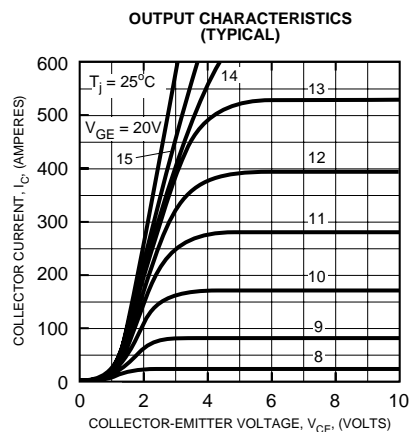

CM300E3U-12H
Chopper IGBTMOD™ U-Series Module
 300 Amperes/600 Volts

HALF-BRIDGE SWITCHING CHARACTERISTICS (TYPICAL)

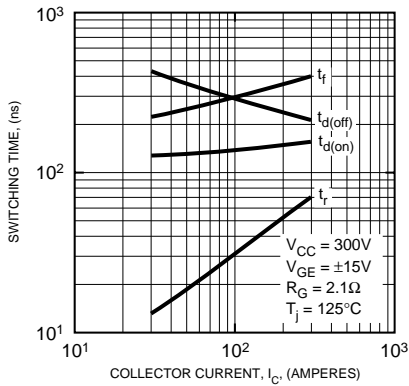

REVERSE RECOVERY CHARACTERISTICS (TYPICAL)

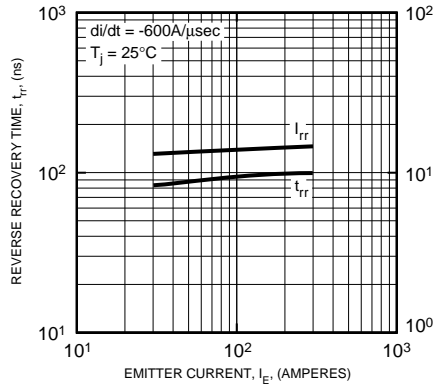

GATE CHARGE, V_GE

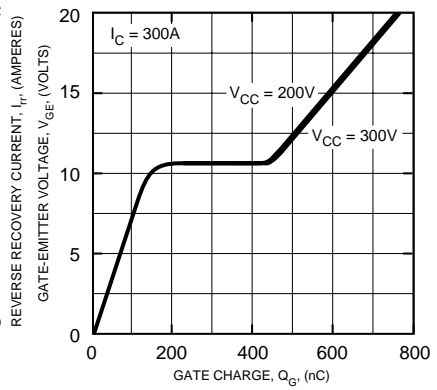

TRANSIENT THERMAL IMPEDANCE CHARACTERISTICS (IGBT)

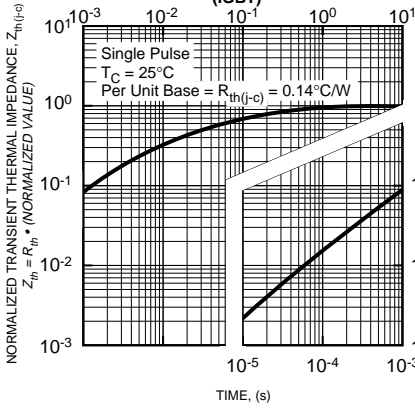

TRANSIENT THERMAL IMPEDANCE CHARACTERISTICS (FWD)

