

MITSUBISHI IGBT MODULES
CM200DU-12NFH

HIGH POWER SWITCHING USE

CM200DU-12NFH



- IC 200A
- VCES 600V
- Insulated Type
- 2-elements in a pack

APPLICATION

High frequency switching use (30kHz to 60kHz).
 Gradient amplifier, Induction heating, power supply, etc.

OUTLINE DRAWING & CIRCUIT DIAGRAM

Dimensions in mm

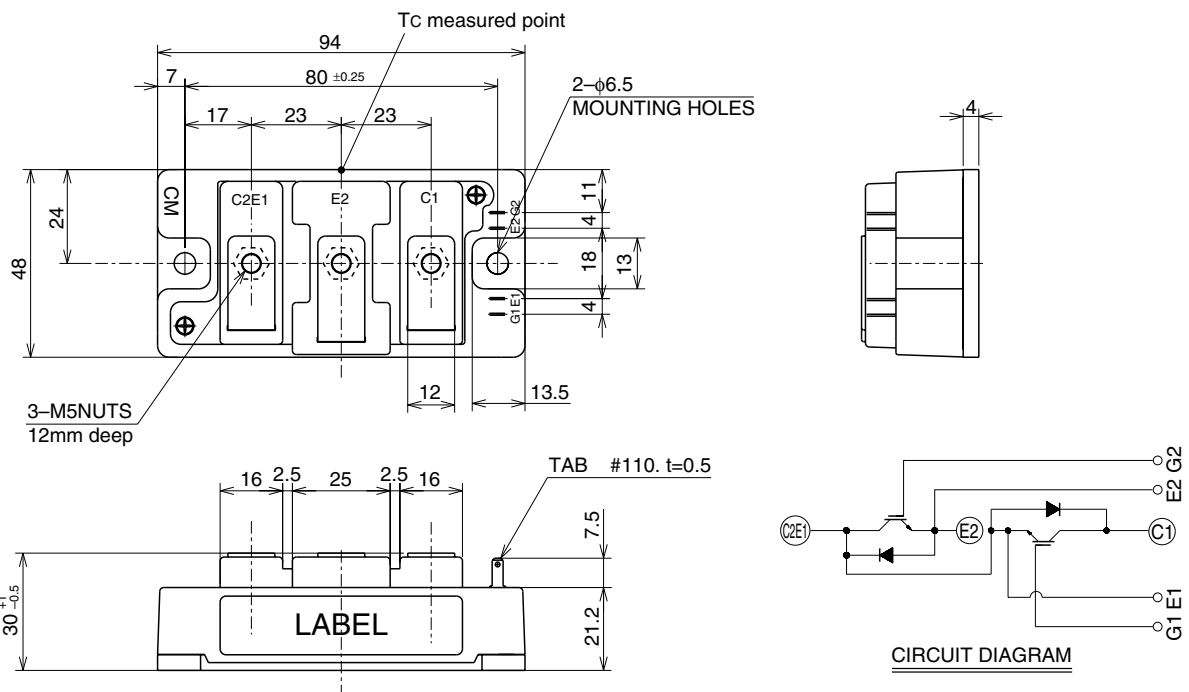

CM200DU-12NFH

HIGH POWER SWITCHING USE

MAXIMUM RATINGS (Tj = 25°C, unless otherwise specified)

Symbol	Parameter	Conditions	Ratings	Unit
V _{CE} S	Collector-emitter voltage	G-E Short	600	V
V _{GE} S	Gate-emitter voltage	C-E Short	±20	V
I _C	Collector current	Operation	200	A
I _{CM}		Pulse (Note 2)	400	A
I _E (Note 1)	Emitter current	Operation	200	A
I _{EM} (Note 1)		Pulse (Note 2)	400	A
P _C (Note 3)	Maximum collector dissipation	T _c = 25°C	590	W
P _C ' (Note 3)	Maximum collector dissipation	T _c ' = 25°C ⁴	830	W
T _j	Junction temperature		-40 ~ +150	°C
T _{stg}	Storage temperature		-40 ~ +125	°C
V _{iso}	Isolation voltage	Terminals to base plate, f = 60Hz, AC 1 minute	2500	V _{rms}
—	Mounting torque	Main terminals M5 screw	2.5 ~ 3.5	N • m
—		Mounting M6 screw	3.5 ~ 4.5	N • m
—	Weight	Typical value	310	g

ELECTRICAL CHARACTERISTICS (Tj = 25°C, unless otherwise specified)

Symbol	Parameter	Test conditions	Limits			Unit	
			Min.	Typ.	Max.		
I _{CE} S	Collector cutoff current	V _{CE} = V _{CE} S, V _{GE} = 0V	—	—	1	mA	
V _{GE(th)}	Gate-emitter threshold voltage	I _C = 20mA, V _{CE} = 10V	5	6	7	V	
I _{GES}	Gate leakage current	±V _{GE} = V _{GES} , V _{CE} = 0V	—	—	0.5	μA	
V _{CE(sat)}	Collector-emitter saturation voltage	I _C = 200A, V _{GE} = 15V	T _j = 25°C	2.0	2.7	V	
			T _j = 125°C	1.95	—		
C _{ies}	Input capacitance	V _{CE} = 10V V _{GE} = 0V	—	—	55	nF	
C _{oes}	Output capacitance		—	—	3.6	nF	
C _{res}	Reverse transfer capacitance		—	—	2.0	nF	
Q _G	Total gate charge	V _{CC} = 300V, I _C = 200A, V _{GE} = 15V	—	1240	—	nC	
t _{d(on)}	Turn-on delay time	V _{CC} = 300V, I _C = 200A V _{GE} = ±15V R _G = 6.3Ω, Inductive load	—	—	250	ns	
t _r	Turn-on rise time		—	—	150	ns	
t _{d(off)}	Turn-off delay time		—	—	500	ns	
t _f	Turn-off fall time		—	—	150	ns	
t _{rr} (Note 1)	Reverse recovery time		I _E = 200A	—	—	150	ns
Q _{rr} (Note 1)	Reverse recovery charge		—	3.5	—	μC	
V _{EC} (Note 1)	Emitter-collector voltage	I _E = 200A, V _{GE} = 0V	—	—	2.6	V	
R _{th(j-c)Q}	Thermal resistance*1	IGBT part (1/2 module)	—	—	0.21	K/W	
R _{th(j-c)R}		FWDi part (1/2 module)	—	—	0.35	K/W	
R _{th(c-f)}	Contact thermal resistance	Case to heat sink, Thermal compound Applied*2 (1/2 module)	—	0.07	—	K/W	
R _{th(j-c)Q}	Thermal resistance	Case temperature measured point is just under the chips (1/2 module)	—	—	0.15*3	K/W	
R _G	External gate resistance		3.1	—	31	Ω	

*1 : Case temperature (T_c) measured point is shown in page OUTLINE DRAWING.

*2 : Typical value is measured by using thermally conductive grease of λ = 0.9[W/(m • K)].

*3 : If you use this value, R_{th(f-a)} should be measured just under the chips.

*4 : Case temperature (T_c) measured point is just under the chips.

Note 1. I_E, V_{EC}, t_{rr} & Q_{rr} represent characteristics of the anti-parallel, emitter-collector free-wheel diode (FWDi).

2. Pulse width and repetition rate should be such that the device junction temperature (T_j) does not exceed T_{jmax} rating.

3. Junction temperature (T_j) should not increase beyond 150°C.

4. No short circuit capability is designed.

PERFORMANCE CURVES

OUTPUT CHARACTERISTICS (TYPICAL)

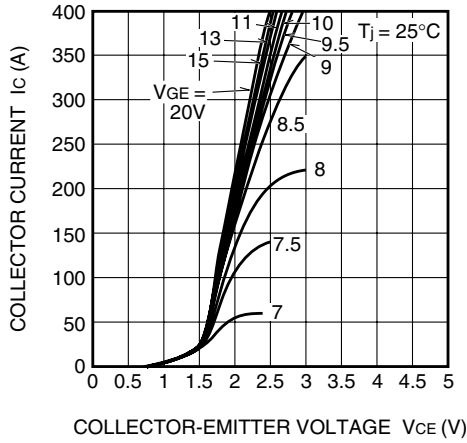

COLLECTOR-EMITTER SATURATION VOLTAGE CHARACTERISTICS (TYPICAL)

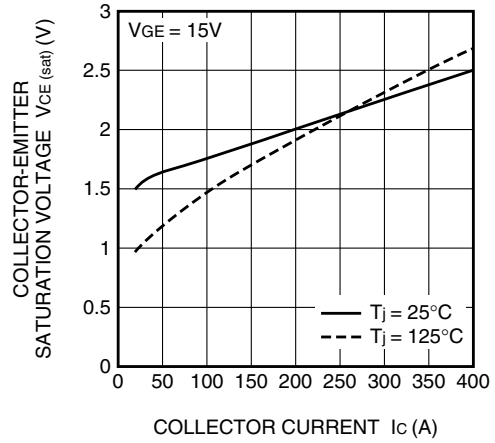

COLLECTOR-EMITTER SATURATION VOLTAGE CHARACTERISTICS (TYPICAL)

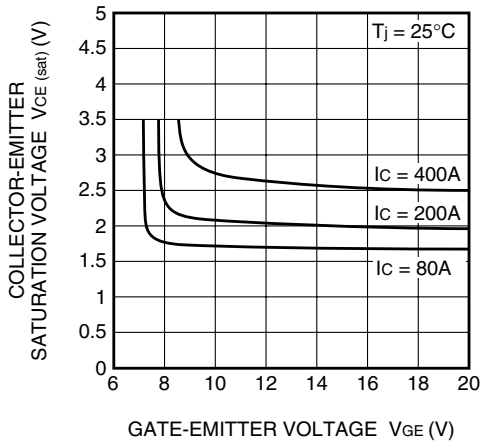

FREE-WHEEL DIODE FORWARD CHARACTERISTICS (TYPICAL)

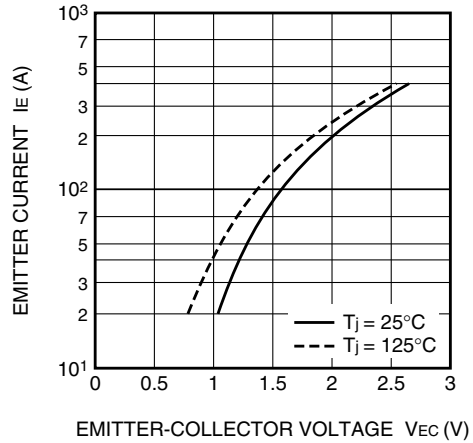

CAPACITANCE- V_{ce} CHARACTERISTICS (TYPICAL)

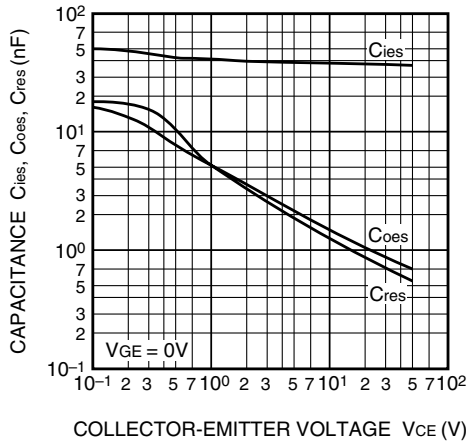

HALF-BRIDGE SWITCHING CHARACTERISTICS (TYPICAL)

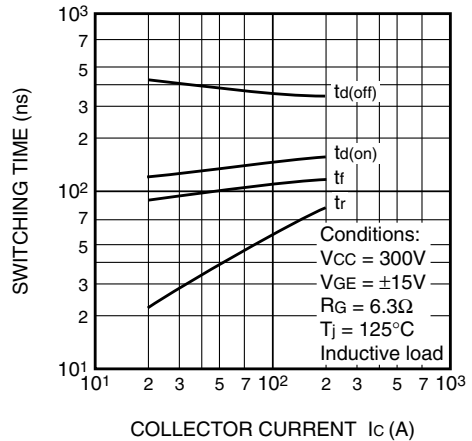

REVERSE RECOVERY CHARACTERISTICS OF FREE-WHEEL DIODE (TYPICAL)

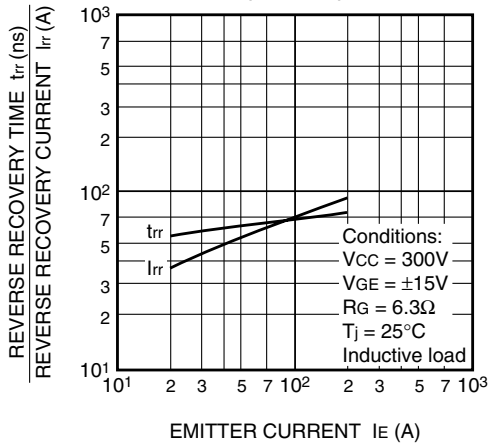

TRANSIENT THERMAL IMPEDANCE CHARACTERISTICS (IGBT part)

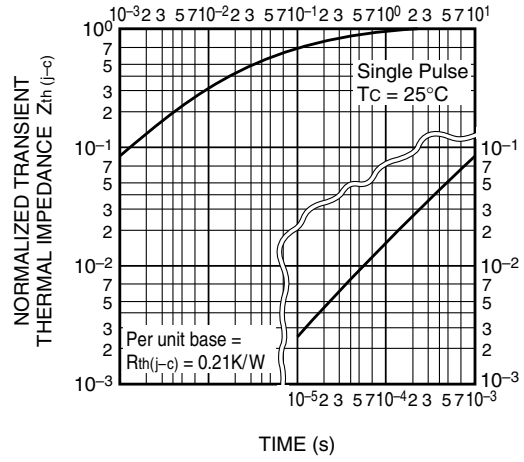

TRANSIENT THERMAL IMPEDANCE CHARACTERISTICS (FWDi part)

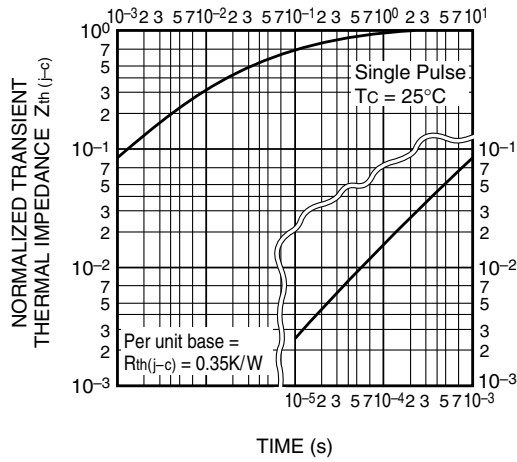

GATE CHARGE CHARACTERISTICS (TYPICAL)

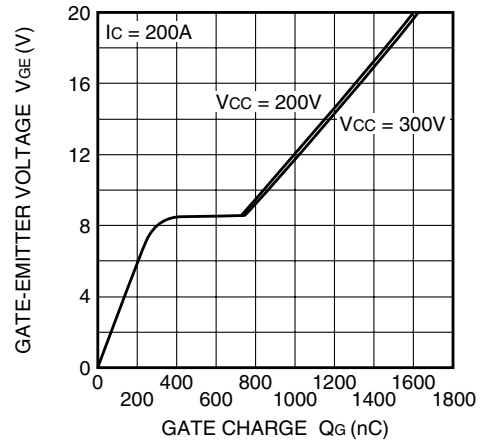

Important Notice

The information contained in this datasheet shall in no event be regarded as a guarantee of conditions or characteristics. This product has to be used within its specified maximum ratings, and is subject to customer's compliance with any applicable legal requirement, norms and standards.

Except as otherwise explicitly approved by Mitsubishi Electric Corporation in a written document signed by authorized representatives of Mitsubishi Electric Corporation, our products may not be used in any applications where a failure of the product or any consequences of the use thereof can reasonably be expected to result in personal injury.

In usage of power semiconductor, there is always the possibility that trouble may occur with them by the reliability lifetime such as Power Cycle, Thermal Cycle or others, or when used under special circumstances (e.g. condensation, high humidity, dusty, salty, highlands, environment with lots of organic matter / corrosive gas / explosive gas, or situations which terminals of semiconductor products receive strong mechanical stress). Therefore, please pay sufficient attention to such circumstances. Further, depending on the technical requirements, our semiconductor products may contain environmental regulation substances, etc. If there is necessity of detailed confirmation, please contact our nearest sales branch or distributor.

The contents or data contained in this datasheet are exclusively intended for technically trained staff. Customer's technical departments should take responsibility to evaluate the suitability of Mitsubishi Electric Corporation product for the intended application and the completeness of the product data with respect to such application. In the customer's research and development, please evaluate it not only with a single semiconductor product but also in the entire system, and judge whether it's applicable. As required, pay close attention to the safety design by installing appropriate fuse or circuit breaker between a power supply and semiconductor products to prevent secondary damage. Please also pay attention to the application note and the related technical information.

Keep safety first in your circuit designs!

Mitsubishi Electric Corporation puts the maximum effort into making semiconductor products better and more reliable, but there is always the possibility that trouble may occur with them. Trouble with semiconductors may lead to personal injury, fire or property damage. Remember to give due consideration to safety when making your circuit designs, with appropriate measures such as (i) placement of substitutive, auxiliary circuits, (ii) use of non-flammable material or (iii) prevention against any malfunction or mishap.

Notes regarding these materials

- These materials are intended as a reference to assist our customers in the selection of the Mitsubishi Electric Semiconductor product best suited to the customer's application; they do not convey any license under any intellectual property rights, or any other rights, belonging to Mitsubishi Electric Corporation or a third party.
- Mitsubishi Electric Corporation assumes no responsibility for any damage, or infringement of any third-party's rights, originating in the use of any product data, diagrams, charts, programs, algorithms, or circuit application examples contained in these materials.
- All information contained in these materials, including product data, diagrams, charts, programs and algorithms represents information on products at the time of publication of these materials, and are subject to change by Mitsubishi Electric Corporation without notice due to product improvements or other reasons. It is therefore recommended that customers contact Mitsubishi Electric Corporation or an authorized Mitsubishi Electric Semiconductor product distributor for the latest product information before purchasing a product listed herein.
The information described here may contain technical inaccuracies or typographical errors. Mitsubishi Electric Corporation assumes no responsibility for any damage, liability, or other loss rising from these inaccuracies or errors.
Please also pay attention to information published by Mitsubishi Electric Corporation by various means, including the Mitsubishi Electric Semiconductor home page (<http://www.MitsubishiElectric.com/semiconductors/>).
- When using any or all of the information contained in these materials, including product data, diagrams, charts, programs, and algorithms, please be sure to evaluate all information as a total system before making a final decision on the applicability of the information and products. Mitsubishi Electric Corporation assumes no responsibility for any damage, liability or other loss resulting from the information contained herein.
- Mitsubishi Electric Corporation semiconductors are not designed or manufactured for use in a device or system that is used under circumstances in which human life is potentially at stake. Please contact Mitsubishi Electric Corporation or an authorized Mitsubishi Electric Semiconductor product distributor when considering the use of a product contained herein for any specific purposes, such as apparatus or systems for transportation, vehicular, medical, aerospace, nuclear, or undersea repeater use.
- The prior written approval of Mitsubishi Electric Corporation is necessary to reprint or reproduce in whole or in part these materials.
- If these products or technologies are subject to the Japanese export control restrictions, they must be exported under a license from the Japanese government and cannot be imported into a country other than the approved destination.
Any diversion or re-export contrary to the export control laws and regulations of Japan and/or the country of destination is prohibited.
- Please contact Mitsubishi Electric Corporation or an authorized Mitsubishi Electric Semiconductor product distributor for further details on these materials or the products contained therein.

Generally the listed company name and the brand name are the trademarks or registered trademarks of the respective companies.