

MITSUBISHI IGBT MODULES  
**CM100E3U-24H**  
 HIGH POWER SWITCHING USE  
 INSULATED TYPE

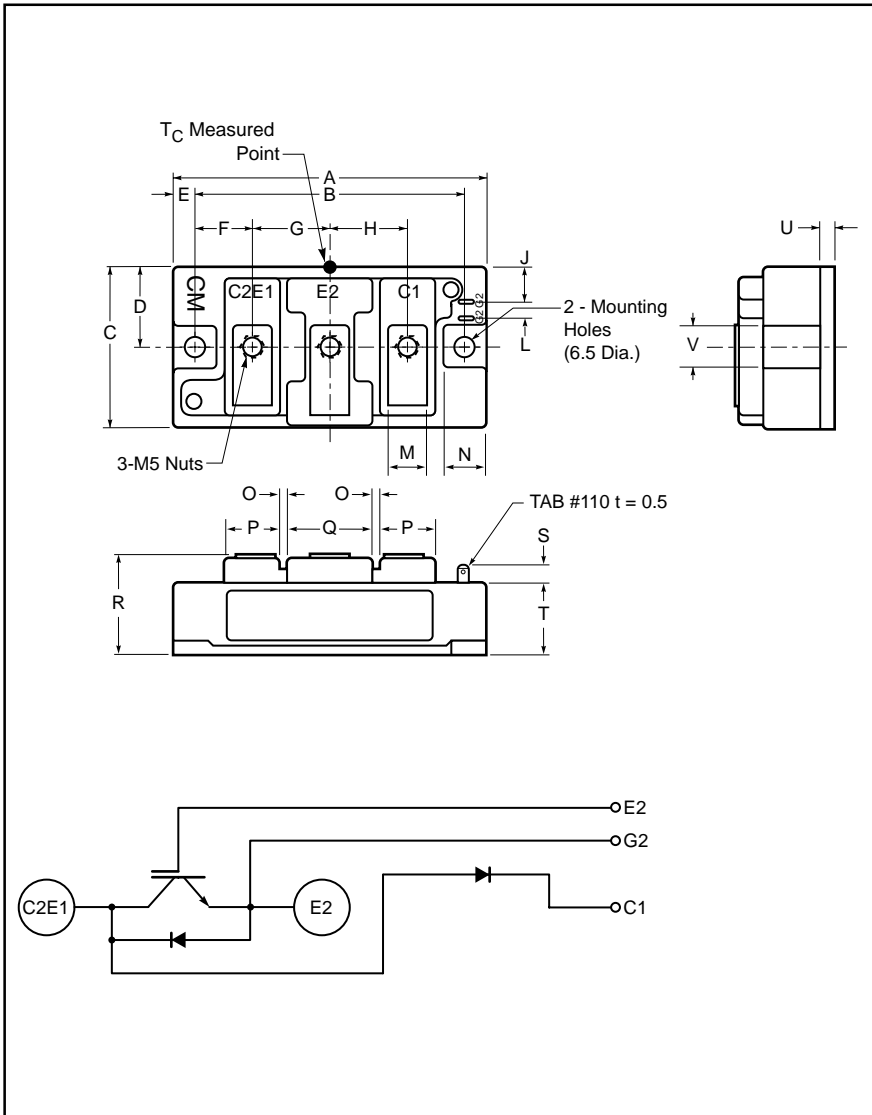

**Description:**

Mitsubishi IGBT Modules are designed for use in switching applications. Each module consists of one IGBT having a reverse-connected super-fast recovery free-wheel diode and an anode-collector connected super-fast recovery free-wheel diode. All components and interconnects are isolated from the heat sinking baseplate, offering simplified system assembly and thermal management.

**Features:**

- Low Drive Power
- Low  $V_{CE(sat)}$
- Discrete Super-Fast Recovery Free-Wheel Diode
- High Frequency Operation
- Isolated Baseplate for Easy Heat Sinking

**Application:**

- Brake

**Ordering Information:**

Example: Select the complete module number you desire from the table - i.e. CM100E3U-24H is a 1200V ( $V_{CES}$ ), 100 Ampere IGBT Module.

Type	Current Rating Amperes	$V_{CES}$ Volts (x 50)
CM	100	24

**Outline Drawing and Circuit Diagram**

Dimensions	Inches	Millimeters
A	3.7	94.0
B	3.15±0.01	80.0±0.25
C	1.89	48.0
D	0.94	24.0
E	0.28	7.0
F	0.67	17.0
G	0.91	23.0
H	0.91	23.0
J	0.43	11.0
L	0.16	4.0

Dimensions	Inches	Millimeters
M	0.47	12.0
N	0.53	13.5
O	0.1	2.5
P	0.63	16.0
Q	0.98	25.0
R	1.18 +0.04/-0.02	30.0 +1.0/-0.5
S	0.3	7.5
T	0.83	21.2
U	0.16	4.0
V	0.51	13.0

**CM100E3U-24H****HIGH POWER SWITCHING USE  
INSULATED TYPE****Absolute Maximum Ratings,  $T_j = 25\text{ }^\circ\text{C}$  unless otherwise specified**

Ratings	Symbol	CM100E3U-24H	Units
Junction Temperature	$T_j$	-40 to 150	$^\circ\text{C}$
Storage Temperature	$T_{stg}$	-40 to 125	$^\circ\text{C}$
Collector-Emitter Voltage (G-E SHORT)	$V_{CES}$	1200	Volts
Gate-Emitter Voltage (C-E SHORT)	$V_{GES}$	$\pm 20$	Volts
Collector Current ( $T_c = 25^\circ\text{C}$ )	$I_C$	100	Amperes
Peak Collector Current	$I_{CM}$	200*	Amperes
Emitter Current** ( $T_c = 25^\circ\text{C}$ )	$I_E$	100	Amperes
Peak Emitter Current**	$I_{EM}$	200*	Amperes
Maximum Collector Dissipation ( $T_c = 25^\circ\text{C}$ , $T_j \leq 150^\circ\text{C}$ )	$P_C$	650	Watts
Mounting Torque, M5 Main Terminal	–	2.5 ~ 3.5	N · m
Mounting Torque, M6 Mounting	–	3.5 ~ 4.5	N · m
Weight	–	310	Grams
Isolation Voltage (Main Terminal to Baseplate, AC 1 min.)	$V_{iso}$	2500	Vrms

\* Pulse width and repetition rate should be such that the device junction temperature ( $T_j$ ) does not exceed  $T_{j(max)}$  rating.

\*\*Represents characteristics of the anti-parallel, emitter-to-collector free-wheel diode (FWDi).

**Static Electrical Characteristics,  $T_j = 25\text{ }^\circ\text{C}$  unless otherwise specified**

Characteristics	Symbol	Test Conditions	Min.	Typ.	Max.	Units
Collector-Cutoff Current	$I_{CES}$	$V_{CE} = V_{CES}$ , $V_{GE} = 0V$	–	–	1	mA
Gate Leakage Voltage	$I_{GES}$	$V_{GE} = V_{GES}$ , $V_{CE} = 0V$	–	–	0.5	$\mu\text{A}$
Gate-Emitter Threshold Voltage	$V_{GE(th)}$	$I_C = 10\text{mA}$ , $V_{CE} = 10V$	4.5	6	7.5	Volts
Collector-Emitter Saturation Voltage	$V_{CE(sat)}$	$I_C = 100A$ , $V_{GE} = 15V$ , $T_j = 25^\circ\text{C}$	–	2.9	3.7	Volts
		$I_C = 100A$ , $V_{GE} = 15V$ , $T_j = 125^\circ\text{C}$	–	2.85	–	Volts
Total Gate Charge	$Q_G$	$V_{CC} = 600V$ , $I_C = 100A$ , $V_{GE} = 15V$	–	375	–	nC
Emitter-Collector Voltage**	$V_{EC}$	$I_E = 100A$ , $V_{GE} = 0V$	–	–	3.2	Volts
Emitter-Collector Voltage	$V_{FM}$	$I_F = 100A$ , Clamp Diode Part	–	–	3.2	Volts

\*\*Represents characteristics of the anti-parallel, emitter-to-collector free-wheel diode (FWDi).

**Dynamic Electrical Characteristics,  $T_j = 25\text{ }^\circ\text{C}$  unless otherwise specified**

Characteristics	Symbol	Test Conditions	Min.	Typ.	Max.	Units	
Input Capacitance	$C_{ies}$		–	–	15	nF	
Output Capacitance	$C_{oes}$	$V_{CE} = 10V$ , $V_{GE} = 0V$	–	–	5	nF	
Reverse Transfer Capacitance	$C_{res}$		–	–	3	nF	
Resistive	Turn-on Delay Time	$t_{d(on)}$	$V_{CC} = 600V$ , $I_C = 100A$ ,	–	–	100	ns
	Rise Time	$t_r$	$V_{GE1} = V_{GE2} = 15V$ ,	–	–	200	ns
Switch	Turn-off Delay Time	$t_{d(off)}$	$R_G = 3.1\Omega$ , Resistive	–	–	300	ns
	Fall Time	$t_f$	Load Switching Operation	–	–	350	ns
Diode Reverse Recovery Time**	$t_{rr}$	$I_E = 100A$ , $di_E/dt = -200A/\mu\text{s}$	–	–	300	ns	
Diode Reverse Recovery Charge**	$Q_{rr}$	$I_E = 100A$ , $di_E/dt = -200A/\mu\text{s}$	–	0.55	–	$\mu\text{C}$	
Diode Reverse Recovery Time	$t_{rr}$	$I_F = 100A$ , Clamp Diode Part	–	–	300	ns	
Diode Reverse Recovery Charge	$Q_{rr}$	$di_F/dt = -200A/\mu\text{s}$	–	0.55	–	$\mu\text{C}$	

\*\*Represents characteristics of the anti-parallel, emitter-to-collector free-wheel diode (FWDi).

# CM100E3U-24H

HIGH POWER SWITCHING USE  
INSULATED TYPE

## Thermal and Mechanical Characteristics, $T_j = 25\text{ }^\circ\text{C}$ unless otherwise specified

Characteristics	Symbol	Test Conditions	Min.	Typ.	Max.	Units
Thermal Resistance, Junction to Case	$R_{th(j-c)Q}$	Per IGBT	-	-	0.19	$^\circ\text{C/W}$
Thermal Resistance, Junction to Case	$R_{th(j-c)D}$	Per FWDi	-	-	0.35	$^\circ\text{C/W}$
Thermal Resistance, Junction to Case	$R_{th(j-c)}$	Clamp Diode Part	-	-	0.35	$^\circ\text{C/W}$
Contact Thermal Resistance	$R_{th(c-f)}$	Per Module, Thermal Grease Applied	-	0.035	-	$^\circ\text{C/W}$

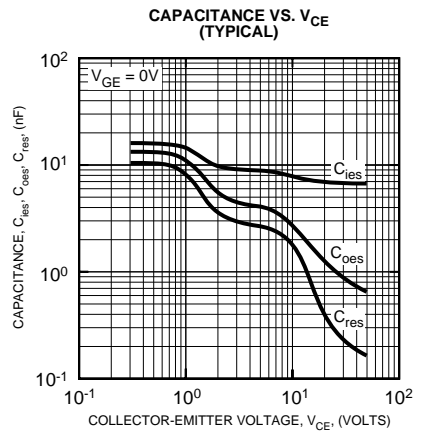
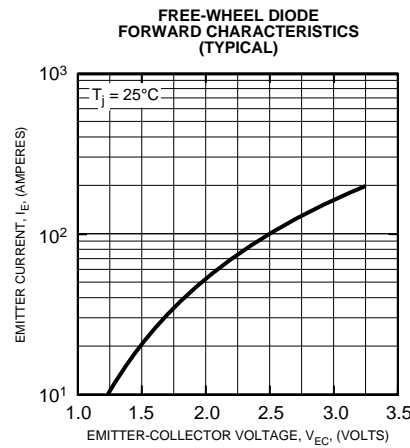
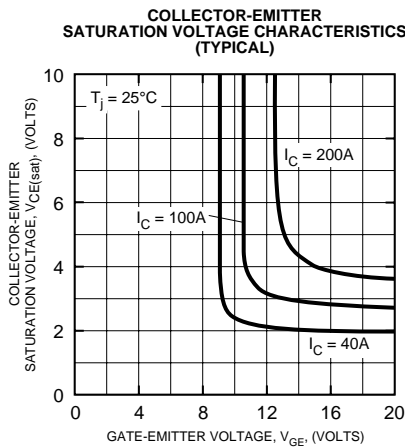
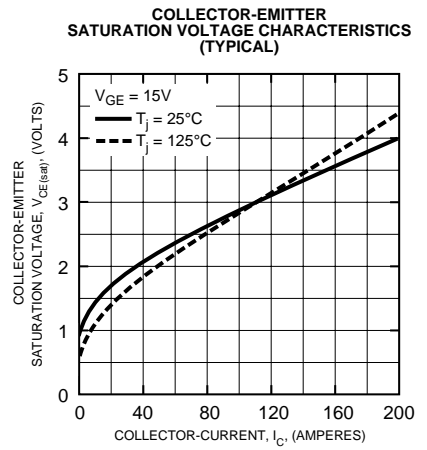
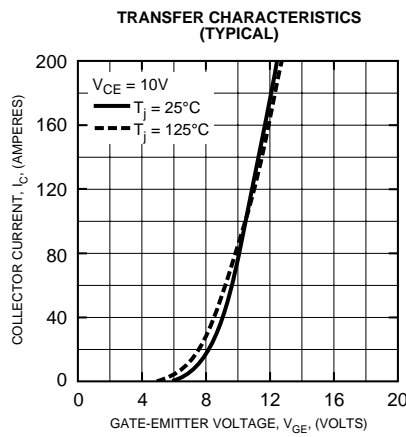
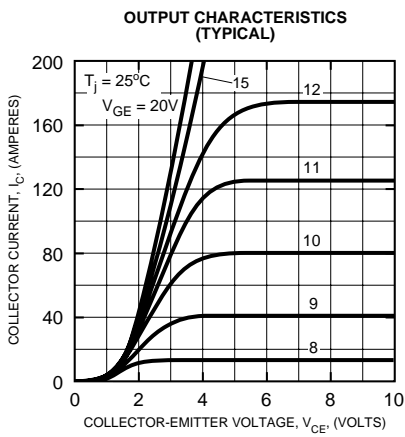

# CM100E3U-24H

HIGH POWER SWITCHING USE  
INSULATED TYPE

HALF-BRIDGE  
SWITCHING CHARACTERISTICS  
(TYPICAL)

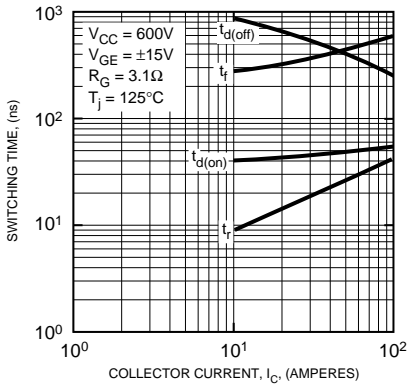

REVERSE RECOVERY CHARACTERISTICS  
(TYPICAL)

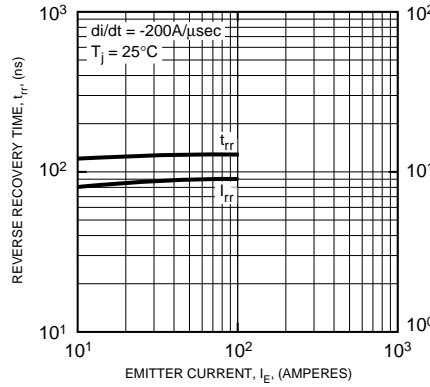

GATE CHARGE,  $V_{GE}$

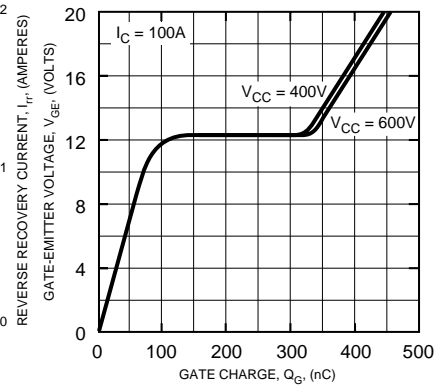

TRANSIENT THERMAL  
IMPEDANCE CHARACTERISTICS  
(IGBT)

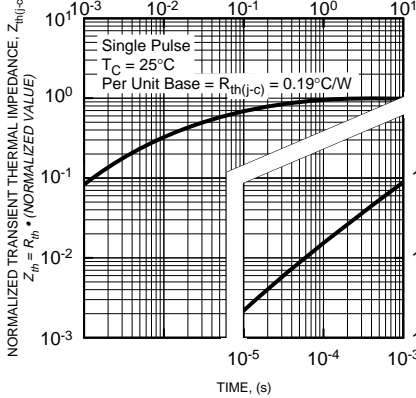

TRANSIENT THERMAL  
IMPEDANCE CHARACTERISTICS  
(FWD)

