

POW-R-BLOK™
Dual SCR Isolated Module
150 Amperes / Up to 1600 Volts

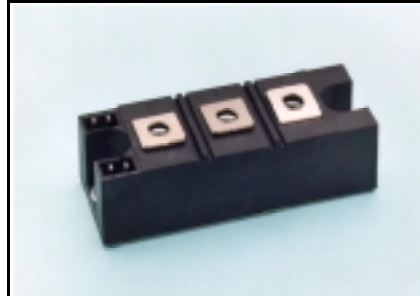
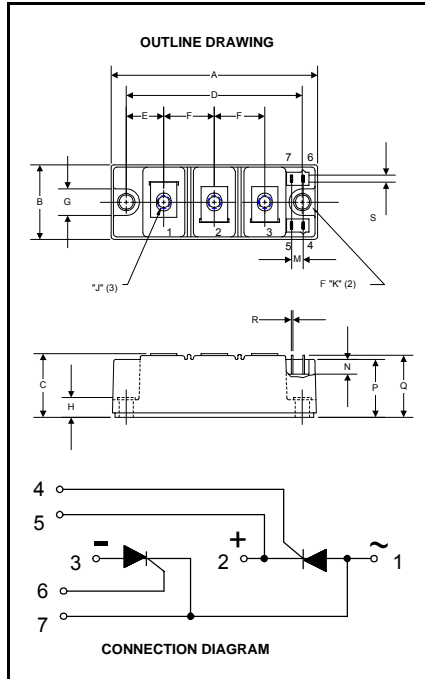

CD63__15A
Dual SCR Isolated
POW-R-BLOK™ Module
 150 Amperes / Up to 1600 Volts

Description:

Powerex Dual SCR Modules are designed for use in applications requiring phase control and isolated packaging. The modules are isolated for easy mounting with other components on a common heatsink. POW-R-BLOK™ has been tested and recognized by the Underwriters Laboratories.

Features:

- Electrically Isolated Heatsinking
- DBC Alumina (Al₂O₃) Insulator
- Glass Passivated Chips
- Metal Baseplate
- Low Thermal Impedance for Improved Current Capability
- Quick Connect Gate Terminal with Provision for Keyed Mating Plug
- UL Recognized (E78240)

CD63_15A Outline Dimensions

Dimension	Inches	Millimeters
A	3.70	94
B	1.38	35
C	1.18	30
D	3.15	80
E	0.67	17
F	0.91	23
G	0.57	14.5
H	0.35	9
J	M6	M6
K	0.26	6.5
M	.020	5
N	0.28	7
P	1.10	28
Q	1.14	29
R	0.03	0.8
S	0.11	2.8

Note: Dimensions are for reference only.

Ordering Information:

Select the complete nine digit module part number from the table below.
 Example: CD631615A is a 1600Volt, 150 Ampere Dual SCR Isolated POW-R-BLOK™ Module

Type	Voltage Volts (x100)	Current Amperes (x 10)
CD63	08	15
	12	
	14	
	16	

Benefits:

- No Additional Insulation Components Required
- Easy Installation
- No Clamping Components Required
- Reduce Engineering Time

Applications:

- Bridge Circuits
- AC & DC Motor Drives
- Battery Supplies
- Power Supplies
- Large IGBT Circuit Front Ends
- Lighting Control
- Heat & Temperature Control
- Welders

Absolute Maximum Ratings

Characteristics	Conditions	Symbol	Units
Repetitive Peak Forward and Reverse Blocking Voltage		V_{DRM} & V_{RRM}	up to 1600 V
Non-Repetitive Peak Reverse Blocking Voltage ($t < 5$ msec)		V_{RSM}	$V_{RRM} + 100$ V
RMS Forward Current	180° Conduction, $T_C=85^\circ\text{C}$	$I_{T(RMS)}$	250 A
	180° Conduction, $T_C=85^\circ\text{C}$ (AC Switch)	$I_{T(RMS)}$	355 A
Average Forward Current	180° Conduction, $T_C=85^\circ\text{C}$	$I_{T(AV)}$	160 A
	180° Conduction, $T_C=90^\circ\text{C}$	$I_{T(AV)}$	150 A
Peak One Cycle Surge Current, Non-Repetitive	60 Hz, 100% V_{RRM} reapplied, $T_J=125^\circ\text{C}$	I_{TSM}	4300 A
	60 Hz, No V_{RRM} reapplied, $T_J=125^\circ\text{C}$	I_{TSM}	5100 A
	50 Hz, 100% V_{RRM} reapplied, $T_J=125^\circ\text{C}$	I_{TSM}	4100 A
	50 Hz, No V_{RRM} reapplied, $T_J=125^\circ\text{C}$	I_{TSM}	4870 A
Peak Three Cycle Surge Current, Non-Repetitive	60 Hz, 100% V_{RRM} reapplied, $T_J=125^\circ\text{C}$	I_{TSM}	3250 A
	50 Hz, 100% V_{RRM} reapplied, $T_J=125^\circ\text{C}$	I_{TSM}	3150 A
Peak Ten Cycle Surge Current, Non-Repetitive	60 Hz, 100% V_{RRM} reapplied, $T_J=125^\circ\text{C}$	I_{TSM}	2650 A
	50 Hz, 100% V_{RRM} reapplied, $T_J=125^\circ\text{C}$	I_{TSM}	2550 A
I^2t for Fusing for One Cycle	8.3 ms, 100% V_{RRM} reapplied, $T_J=125^\circ\text{C}$	I^2t	76,700 A^2sec
	8.3 ms, No V_{RRM} reapplied, $T_J=125^\circ\text{C}$	I^2t	108,000 A^2sec
	10 ms, 100% V_{RRM} reapplied, $T_J=125^\circ\text{C}$	I^2t	84,000 A^2sec
	10 ms, No V_{RRM} reapplied, $T_J=125^\circ\text{C}$	I^2t	119,000 A^2sec
Maximum Rate-of-Rise of On-State Current, Non Repetitive	$T_J=125^\circ\text{C}$, $V_D = V_{DRM}$ (Rated), $I_{TM}=400\text{A}$, $I_G=0.5\text{A}$, $T_r < 0.25\mu\text{s}$, $t_p > 6\mu\text{s}$	di/dt	300 $\text{A}/\mu\text{s}$
Peak Gate Power Dissipation	$T_p < 5$ ms, $T_J = 125^\circ\text{C}$	P_{GM}	12 W
Average Gate Power Dissipation	$F = 50$ Hz, $T_J = 125^\circ\text{C}$	$P_{G(AV)}$	3 W
Peak Forward Gate Current	$T_p < 5$ ms, $T_J = 125^\circ\text{C}$	I_{GFM}	3 A
Peak Reverse Gate Voltage	$T_p < 5$ ms, $T_J = 125^\circ\text{C}$	V_{GRM}	10 V
Operating Temperature		T_J	-40 to +125 $^\circ\text{C}$
Storage Temperature		T_{stg}	-40 to +150 $^\circ\text{C}$
Max. Mounting Torque, M6 Mounting Screw on Terminals			35 - 50 in.-Lb.
			4 - 6 Nm
Max. Mounting Torque, Module to Heatsink			35 - 50 in.-Lb.
			4 - 6 Nm
Module Weight, Typical			200 g
			7.1 oz.
V Isolation @ 25C		V_{rms}	3500 V

Electrical Characteristics, T_J=25°C unless otherwise specified

Characteristics	Symbol	Test Conditions	Min.	Max.	Units
Repetitive Peak Forward Leakage Current	I _{DRM}	Up to 1600V, T _J =125°C		50	mA
Repetitive Peak Reverse Leakage Current	I _{RRM}	Up to 1600V, T _J =125°C		50	mA
Peak On-State Voltage	V _{TM}	I _{TM} =500A		1.54	V
Threshold Voltage, Low-level	V _{(TO)1}	T _J = 125°C, I = 16.7% x I _{T(AV)} to I _{T(AV)}		0.80	V
Slope Resistance, Low-level	r _{T1}			1.67	mΩ
Threshold Voltage, High-level	V _{(TO)2}	T _J = 125°C, I = I _{T(AV)} to I _{TSM}		0.98	V
Slope Resistance, High-level	r _{T2}			1.38	mΩ
V _{TM} Coefficients, Full Range		T _J = 125°C, I = 15% x I _{T(AV)} to I _{TSM} V _{TM} = A + B Ln I + C I + D Sqrt I	A = B = C = D =	0.5926 -1.10E-03 1.03E-03 0.0241	
Minimum dV/dt	dV/dt	Exponential to 2/3 V _{DRM} T _J =125°C, Gate Open	1000		V/μs
Turn-On Time (Typical)	t _{on}	I _{TM} = 300A, V _D = 2/3 V _{DRM} dI/dt = 1A/μs	3	(Typical)	μs
Turn-Off Time (Typical)	t _{off}	T _J = 125°C, I _T = 300A, R _{gk} = 100Ω V _r = 50V, -dI/dt = 15 A/μs Re-Applied dV/dt = 20V/μs, Linear to 2/3 V _{DRM}	50 - 200	(Typical)	μs
Gate Trigger Current	I _{GT}	T _J = -40°C, V _D =6V, R _a =1Ω, Resistive Load T _J = 25°C, V _D =6V, R _a =1Ω, Resistive Load T _J =125°C, V _D =6V, R _a =1Ω, Resistive Load		270 150 80	mA mA mA
Gate Trigger Voltage	V _{GT}	T _J = -40°C, V _D =6V, R _a =1Ω, Resistive Load T _J = 25°C, V _D =6V, R _a =1Ω, Resistive Load T _J =125°C, V _D =6V, R _a =1Ω, Resistive Load		4.0 2.5 1.7	Volts Volts Volts
Non-Triggering Gate Voltage	V _{GDM}	T _J =125°C, V _D =V _{DRM}		0.30	Volts
Non-Triggering Gate Current	I _{GDM}	T _J =125°C, V _D =V _{DRM}		10	mA

Thermal Characteristics

Characteristics	Symbol		Max.	Units
Thermal Resistance, Junction to Case DC Operation	R _{ΘJ-C}	Per Module, both conducting Per Junction, both conducting	0.08 0.16	°C/W °C/W
Thermal Impedance Coefficients (Per Junction)	Z _{ΘJ-C}	Z _{ΘJ-C} = K ₁ (1-exp(-t/τ ₁)) + K ₂ (1-exp(-t/τ ₂)) + K ₃ (1-exp(-t/τ ₃)) + K ₄ (1-exp(-t/τ ₄))	K ₁ = 5.45334E-3 K ₂ = 3.8509E+1 K ₃ = -3.5154E+1 K ₄ = -3.20	τ ₁ = 4.511E-5 τ ₂ = 1.3558E-1 τ ₃ = 1.3311E-1 τ ₄ = 1.5936E-1
Thermal Resistance, Case to Sink Lubricated	R _{ΘC-S}	Per Module	0.05	°C/W

POW-R-BLOK™ Dual SCR Isolated Module 150 Amperes / Up to 1600 Volts

Maximum On-State Forward Voltage Drop
($T_j = 125^\circ\text{C}$)

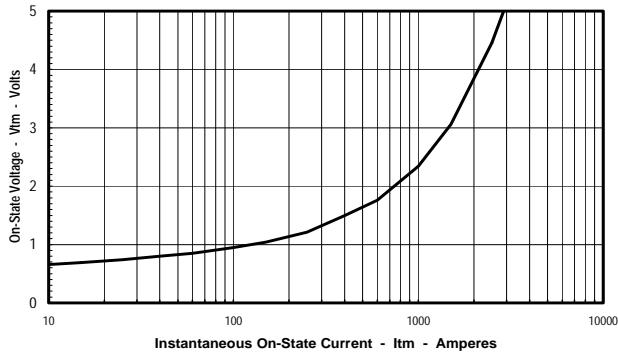

Maximum Transient Thermal Impedance
(Junction to Case)

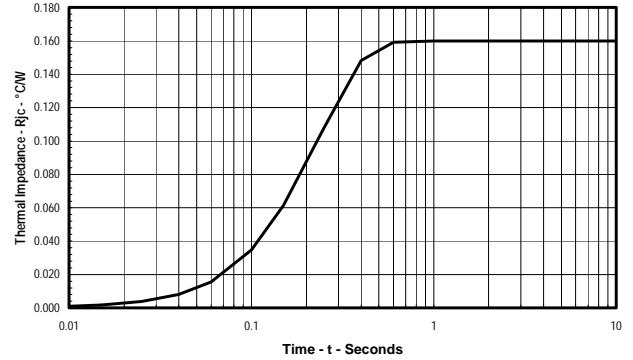

Maximum On-State Power Dissipation
(Sinusoidal Waveform)

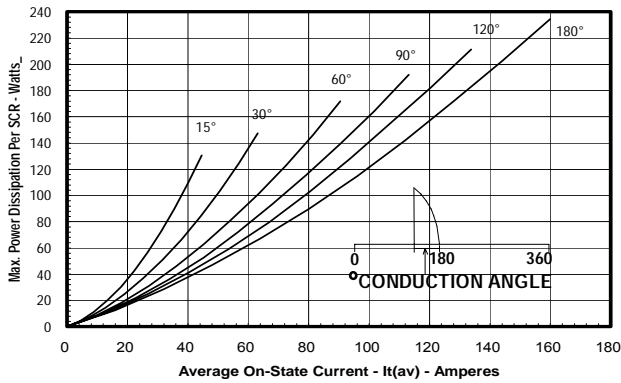

Maximum Allowable Case Temperature
(Sinusoidal Waveform)

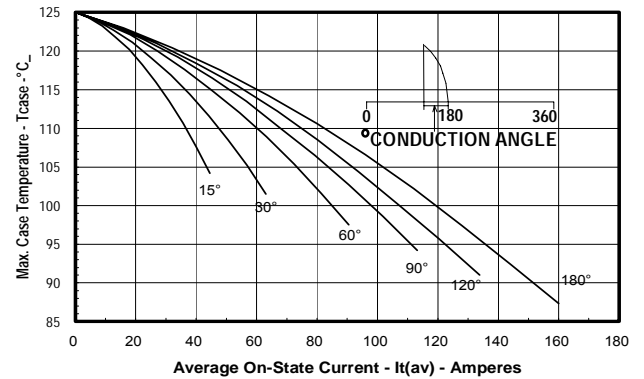

Maximum On-State Power Dissipation
(Rectangular Waveform)

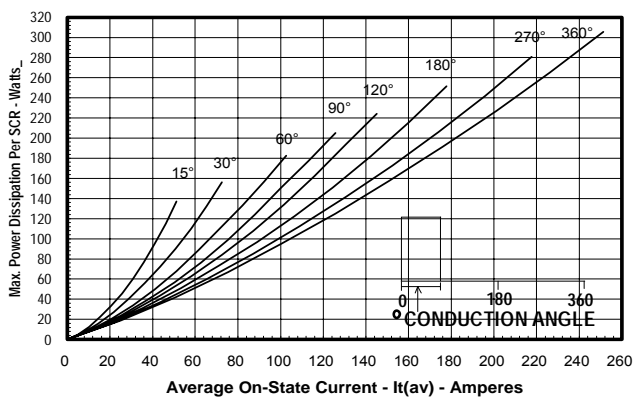

Maximum Allowable Case Temperature
(Rectangular Waveform)

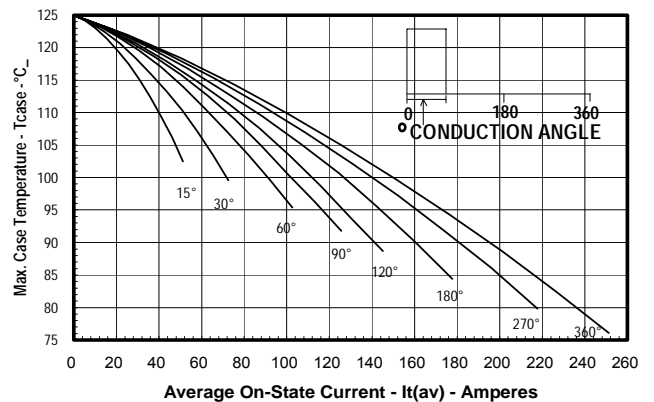

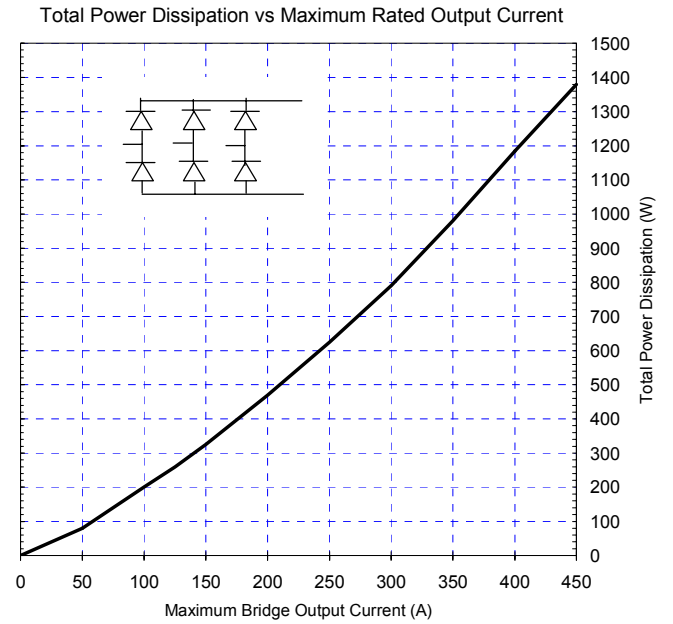
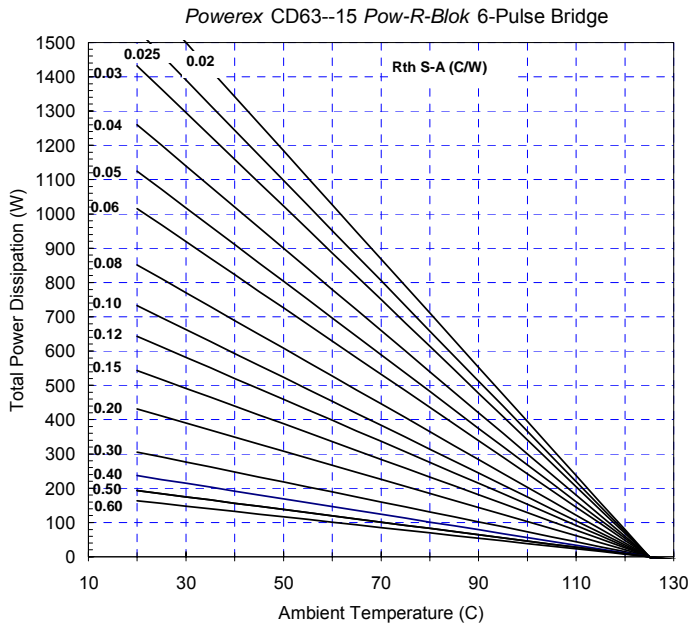

Six-Pulse Bridge Circuit Total Power Dissipation & Maximum Rated Output Current With Sink to Ambient Resistance of Heatsink as a Parameter.