

Powerex, Inc., Hillis Street, Youngwood, Pennsylvania 15697 (724) 925-7272
www.pwr.com

POW-R-BLOK™
Dual SCR Isolated Module
150 Amperes / Up to 1800 Volts

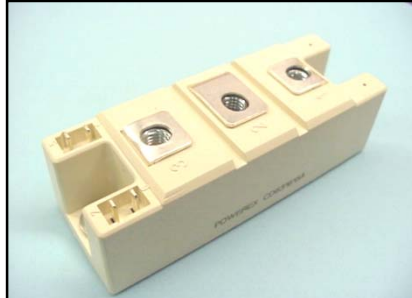
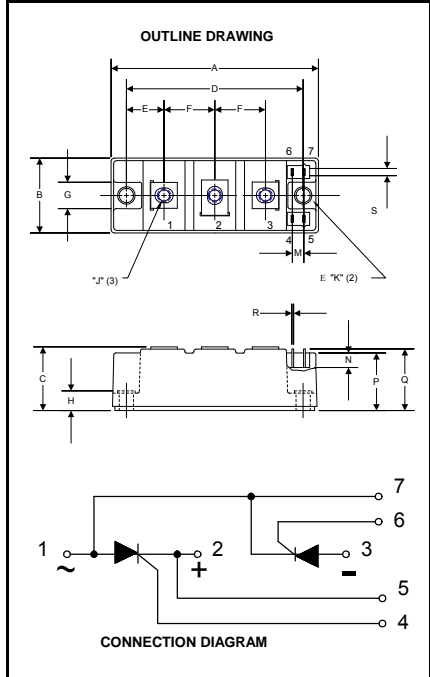

CD63__15B
Dual SCR Isolated
POW-R-BLOK™ Module
150 Amperes / Up to 1800 Volts

CD63_15B Outline Dimensions

Dimension	Inches	Millimeters
A	3.70	94
B	1.34	34
C	1.18	30
D	3.15	80
E	0.67	17
F	0.91	23
G	0.51	13
H	0.35	8.3
J	M6	M6
K	0.26	6.4
M	.020	5
N	0.28	6
P	1.06	27
Q	1.14	29
R	0.03	0.8
S	0.11	2.8

Note: Dimensions are for reference only.

Ordering Information:

Select the complete nine digit module part number from the table below.
Example: CD631615B is a 1600Volt, 150 Ampere Dual SCR Isolated POW-R-BLOK™ Module

Type	Voltage Volts (x100)	Current Amperes (x 10)	Version
CD63	08 12 14 16 18	15	B

Description:

Powerex Dual SCR Modules are designed for use in applications requiring phase control and isolated packaging. The modules are isolated for easy mounting with other components on a common heatsink. POW-R-BLOK™ has been tested and recognized by the Underwriters Laboratories.

Features:

- Electrically Isolated Heatsinking
- DBC Alumina (Al₂O₃) Insulator
- Glass Passivated Chips
- Metal Baseplate
- Low Thermal Impedance for Improved Current Capability
- Quick Connect Gate Terminal with Provision for Keyed Mating Plug
- UL Recognized (E78240)

Benefits:

- No Additional Insulation Components Required
- Easy Installation
- No Clamping Components Required
- Reduce Engineering Time

Applications:

- Bridge Circuits
- AC & DC Motor Drives
- Battery Supplies
- Power Supplies
- Large IGBT Circuit Front Ends
- Lighting Control
- Heat & Temperature Control
- Welders

Absolute Maximum Ratings

Characteristics	Conditions	Symbol	Units
Repetitive Peak Forward and Reverse Blocking Voltage		V_{DRM} & V_{RRM}	up to 1800 V
Non-Repetitive Peak Reverse Blocking Voltage (t < 5 msec)		V_{RSM}	$V_{RRM} + 100$ V
RMS Forward Current	180° Conduction, $T_C=85^\circ\text{C}$	$I_{T(RMS)}$	235 A
Average Forward Current	180° Conduction, $T_C=82^\circ\text{C}$	$I_{T(AV)}$	160 A
	180° Conduction, $T_C=85^\circ\text{C}$	$I_{T(AV)}$	150 A
Peak One Cycle Surge Current, Non-Repetitive	60 Hz, 100% V_{RRM} reapplied, $T_J=125^\circ\text{C}$	I_{TSM}	3700 A
	60 Hz, No V_{RRM} reapplied, $T_J=125^\circ\text{C}$	I_{TSM}	5250 A
	50 Hz, 100% V_{RRM} reapplied, $T_J=125^\circ\text{C}$	I_{TSM}	3520 A
	50 Hz, No V_{RRM} reapplied, $T_J=125^\circ\text{C}$	I_{TSM}	5000 A
Peak Three Cycle Surge Current, Non-Repetitive	60 Hz, 100% V_{RRM} reapplied, $T_J=125^\circ\text{C}$	I_{TSM}	2970 A
	50 Hz, 100% V_{RRM} reapplied, $T_J=125^\circ\text{C}$	I_{TSM}	2830 A
Peak Ten Cycle Surge Current, Non-Repetitive	60 Hz, 100% V_{RRM} reapplied, $T_J=125^\circ\text{C}$	I_{TSM}	2335 A
	50 Hz, 100% V_{RRM} reapplied, $T_J=125^\circ\text{C}$	I_{TSM}	2220 A
I^2t for Fusing for One Cycle	8.3 ms, 100% V_{RRM} reapplied, $T_J=125^\circ\text{C}$	I^2t	57,040 A ² sec
	8.3 ms, No V_{RRM} reapplied, $T_J=125^\circ\text{C}$	I^2t	114,840 A ² sec
	10 ms, 100% V_{RRM} reapplied, $T_J=125^\circ\text{C}$	I^2t	61,950 A ² sec
	10 ms, No V_{RRM} reapplied, $T_J=125^\circ\text{C}$	I^2t	125,000 A ² sec
Maximum Rate-of-Rise of On-State Current, Non Repetitive	$T_J=125^\circ\text{C}$, $V_D=V_{DRM(Rated)}$, $I_{TM}=400\text{A}$, $I_G=0.5\text{A}$, $T_R < 0.25\mu\text{s}$, $t_p > 6\mu\text{s}$	di/dt	200 A/ μs
Peak Gate Power Dissipation	$T_p < 5\text{ms}$, $T_J = 125^\circ\text{C}$	P_{GM}	12 W
Average Gate Power Dissipation	$F = 50\text{Hz}$, $T_J = 125^\circ\text{C}$	$P_{G(AV)}$	3 W
Peak Forward Gate Current	$T_p < 5\text{ms}$, $T_J = 125^\circ\text{C}$	I_{GFM}	3 A
Peak Reverse Gate Voltage	$T_p < 5\text{ms}$, $T_J = 125^\circ\text{C}$	V_{GRM}	10 V
Operating Temperature		T_J	-40 to +125 °C
Storage Temperature		T_{stg}	-40 to +125 °C
Max. Mounting Torque, M6 Mounting Screw on Terminals			35 - 50 in.-Lb.
			4 - 6 Nm
Max. Mounting Torque, Module to Heatsink			35 - 50 in.-Lb.
			4 - 6 Nm
Module Weight, Typical			165 g
			0.36 oz.
V Isolation	$T_J = 25^\circ\text{C}$, 1 second	V_{rms}	3600 V
	$T_J = 25^\circ\text{C}$, 1 minute	V_{rms}	3000 V

Electrical Characteristics, $T_J=25^\circ\text{C}$ unless otherwise specified

Characteristics	Symbol	Test Conditions	Min.	Max.	Units
Repetitive Peak Forward Leakage Current	I_{DRM}	Up to 1800V, $T_J=125^\circ\text{C}$		50	mA
Repetitive Peak Reverse Leakage Current	I_{RRM}	Up to 1800V, $T_J=125^\circ\text{C}$		50	mA
Peak On-State Voltage	V_{TM}	$I_{TM}=500\text{A}$		1.6	V
Threshold Voltage, Low-level	$V_{(TO)1}$	$T_J = 125^\circ\text{C}$, $I = 16.7\% \times \pi I_{T(AV)}$ to $\pi I_{T(AV)}$		0.85	V
Slope Resistance, Low-level	r_{T1}			1.5	m Ω
Minimum dV/dt	dV/dt	Exponential to $2/3 V_{DRM}$ $T_J=125^\circ\text{C}$, Gate Open	1000		V/ μs
Turn-Off Time (Typical)	t_{off}	$T_J = 125^\circ\text{C}$, $I_T = 300\text{A}$, $R_{gk} = 100\Omega$ $V_f = 50\text{V}$, $-dI/dt = 15\text{ A}/\mu\text{s}$ Re-Applied dV/dt = $20\text{V}/\mu\text{s}$, Linear to $2/3 V_{DRM}$	50 - 200	(Typical)	μs
Gate Trigger Current	I_{GT}	$T_J = 25^\circ\text{C}$, $V_D=6\text{V}$, $R_g=1\Omega$, Resistive Load		150	mA
Gate Trigger Voltage	V_{GT}	$T_J = 25^\circ\text{C}$, $V_D=6\text{V}$, $R_g=1\Omega$, Resistive Load		2.0	Volts
Non-Triggering Gate Voltage	V_{GDM}	$T_J=125^\circ\text{C}$, $V_D=V_{DRM}$		0.25	Volts
Non-Triggering Gate Current	I_{GDM}	$T_J=125^\circ\text{C}$, $V_D=V_{DRM}$		10	mA
Holding Current	I_H	$T_J=25^\circ\text{C}$	150	(Typical)	mA
Latching Current	I_L	$T_J=25^\circ\text{C}$	300	(Typical)	mA

Thermal Characteristics

Characteristics	Symbol		Max.	Units
Thermal Resistance, Junction to Case DC Operation	$R_{\theta J-C}$	Per Module, both conducting Per Junction, both conducting	0.085 0.17	$^\circ\text{C}/\text{W}$ $^\circ\text{C}/\text{W}$
Thermal Resistance, Case to Sink Lubricated	$R_{\theta C-S}$	Per Module	0.05	$^\circ\text{C}/\text{W}$

Information presented is based upon manufacturers testing and projected capabilities.
 This information is subject to change without notice.
 The manufacturer makes no claim as to the suitability of use, reliability, capability,
 or future availability of this product.

Powerex, Inc., Hillis Street, Youngwood, Pennsylvania 15697 (724) 925-7272
www.pwr.com

POW-R-BLOK™
Dual SCR Isolated Module
150 Amperes / Up to 1800 Volts

Maximum On-State Forward Voltage Drop
($T_j = 125^\circ\text{C}$)

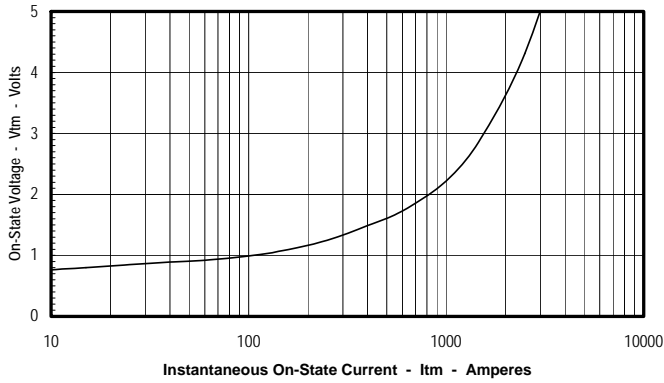

Maximum Transient Thermal Impedance
(Junction to Case)

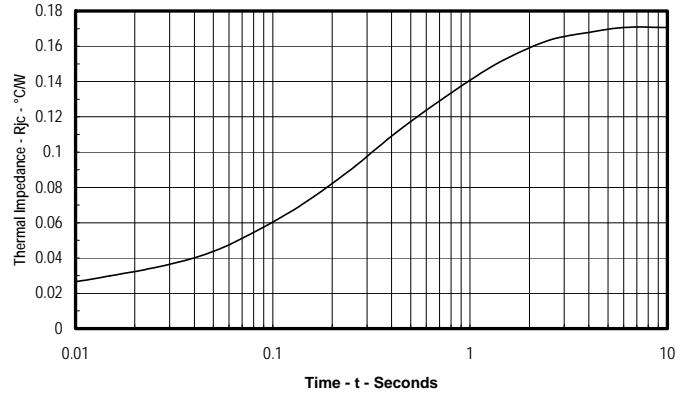

Maximum On-State Power Dissipation
(Sinusoidal Waveform)

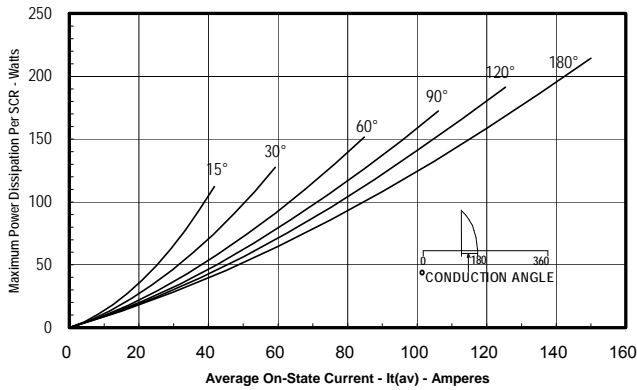

Maximum Allowable Case Temperature
(Sinusoidal Waveform)

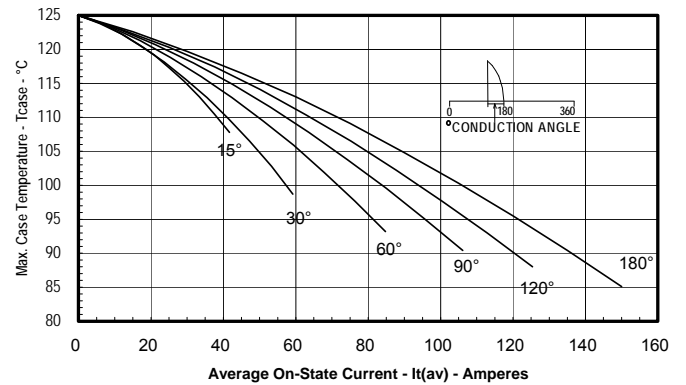

Maximum On-State Power Dissipation
(Rectangular Waveform)

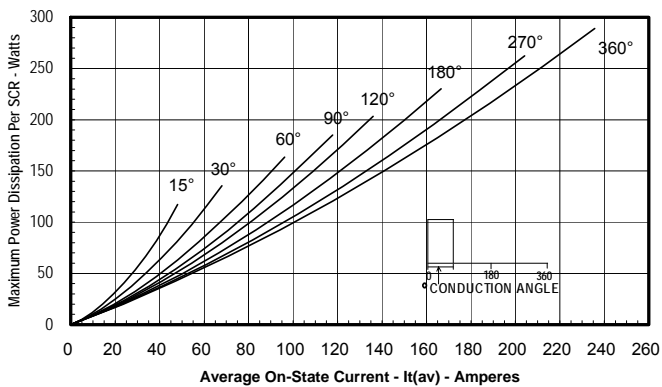

Maximum Allowable Case Temperature
(Rectangular Waveform)

