

Powerex, Inc., 200 Hillis Street, Youngwood, Pennsylvania 15697-1800 (412) 925-7272  
 Powerex, Europe, S.A. 428 Avenue G. Durand, BP107, 72003 Le Mans, France (43) 41.14.14

**Phase Control SCR**  
 1650 Amperes Average  
 4500 Volts

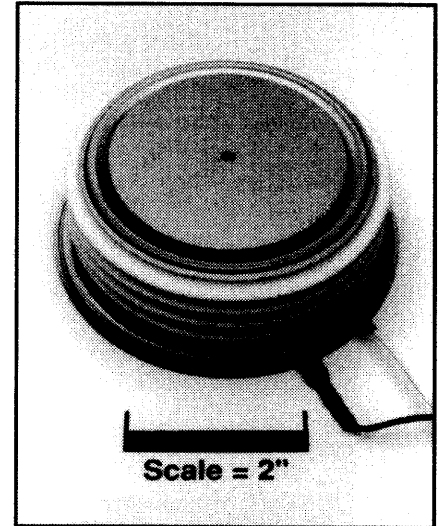
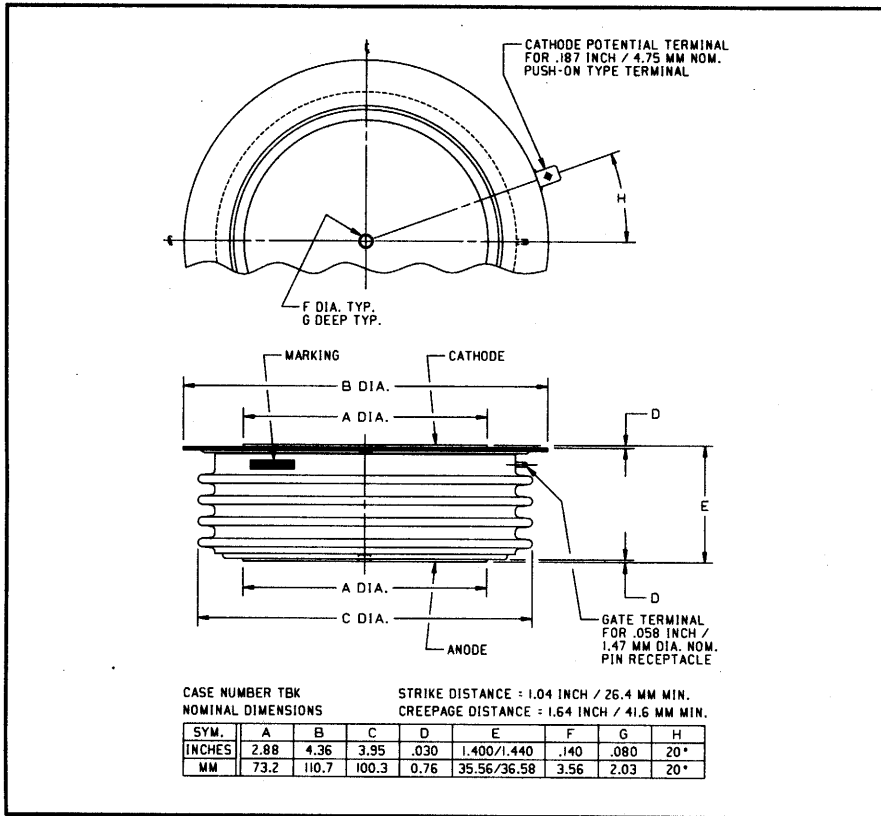

**C784 Phase Control SCR**  
 1650 Amperes Average, 4500 Volts

**C784 (Outline Drawing)**

### Description:

Powerex Silicon Controlled Rectifiers (SCR) are designed for phase control applications. These are all-diffused, Press-Pak, hermetic Pow-R-Disc devices employing the field proven amplifying gate.

### Features:

- Low On-State Voltage
- High di/dt Capability
- High dv/dt Capability
- Hermetic Packaging
- Excellent Surge and  $I^2t$  Ratings

### Applications:

- Power Supplies
- Motor Control
- VAR Generators

### Ordering Information:

Select the complete six digit part number you desire from the table, i.e. C784DE is a 4500 Volt, 1650 Ampere Phase Control SCR.

Type	Voltage		Current
	$V_{DRM}$ $V_{RRM}$	Code	$I_{T(av)}$
C784	3600	CM	1650
	3800	CN	
	4000	DP	
	4200	DB	
	4400	DD	
	4500	DE	



Powerex, Inc., 200 Hillis Street, Youngwood, Pennsylvania 15697-1800 (412) 925-7272  
Powerex, Europe, S.A. 428 Avenue G. Durand, BP107, 72003 Le Mans, France (43) 41.14.14

**C784**  
**Phase Control SCR**  
1650 Amperes Average, 4500 Volts

### Absolute Maximum Ratings

Characteristics	Symbol	C784	Units
Non-repetitive Transient Peak Reverse Voltage	$V_{RSM}$	$V_{RRM} + 100V$	Volts
RMS On-state Current, $T_C = 70^\circ C$	$I_T(rms)$	2590	Amperes
Average Current 180° Sine Wave, $T_C = 70^\circ C$	$I_T(av)$	1650	Amperes
RMS On-state Current, $T_C = 55^\circ C$	$I_T(rms)$	3030	Amperes
Average Current 180° Sine Wave, $T_C = 55^\circ C$	$I_T(av)$	1930	Amperes
Peak One Cycle Surge On-state Current (Non-repetitive) 60Hz	$I_{tsm}$	26000	Amperes
Peak One Cycle Surge On-state Current (Non-repetitive) 50Hz	$I_{tsm}$	24000	Amperes
Critical Rate-of-rise of On-state Current (Non-repetitive)	$di/dt$	600	A/ $\mu$ sec
Critical Rate-of-rise of On-state Current (Repetitive)	$di/dt$	100	A/ $\mu$ sec
$I^2t$ (for Fusing) for One Cycle, 60Hz	$I^2t$	$2.75 \times 10^6$	A <sup>2</sup> sec
Peak Gate Power Dissipation	$P_{GM}$	250	Watts
Average Gate Power Dissipation	$P_{G(av)}$	35	Watts
Operating Temperature	$T_j$	-40 to +125°C	°C
Storage Temperature	$T_{stg}$	-40 to +150°C	°C
Approximate Weight		3.5	lb.
		1.60	kg
Mounting Force		9000 to 10000	lb.
		40 to 44.5	kN

**C784**

**Phase Control SCR**

1650 Amperes Average, 4500 Volts

**Electrical Characteristics,  $T_j = 25^\circ\text{C}$  Unless Otherwise Specified**

Characteristics	Symbol	Test Conditions	Min.	Typ.	Max.	Units
Repetitive Peak Reverse Leakage Current	$I_{RRM}$	$T_j = 125^\circ\text{C}, V_R = V_{RRM}$			200	mA
Repetitive Peak Forward Leakage Current	$I_{DRM}$	$T_j = 125^\circ\text{C}, V_D = V_{DRM}$			300	mA
Peak On-state Voltage	$V_{TM}$	$I_{TM} = 2000\text{A Peak}$ Duty Cycle < 0.1%			1.85	Volts
Threshold Voltage, Low-level	$V_{(TO)1}$	$T_j = 125^\circ\text{C}, I = 15\%, I_{T(av)}$ to $\pi I_{T(av)}$			1.0325	Volts
Slope Resistance, Low-level	$r_{T1}$				0.35754	m $\Omega$
Threshold Voltage, High-level	$V_{(TO)2}$	$T_j = 125^\circ\text{C}, I = \pi I_{T(av)}$ to $I_{TSM}$			1.14596	Volts
Slope Resistance, High-level	$r_{T2}$				0.33617	m $\Omega$
$V_{TM}$ Coefficients, Low-level		$T_j = 125^\circ\text{C}, I = 15\% I_{T(av)}$ to $\pi I_{T(av)}$				
					$A_1 = 1.3364$	
					$B_1 = -0.15271$	
					$C_1 = 8.369\text{E-}05$	
					$D_1 = 0.033344$	
$V_{TM}$ Coefficients, High-level		$T_j = 125^\circ\text{C}, I = \pi I_{T(av)}$ to $I_{TSM}$				
					$A_2 = 27.25$	
					$B_2 = -4.2789$	
					$C_2 = -8.503\text{E-}05$	
					$D_2 = 0.17524$	
Typical Delay Time	$t_d$	$T_j = 125^\circ\text{C}, V_D = 2000\text{V}$		3.0		$\mu\text{sec}$
Typical Turn-off Time	$t_q$	$T_j = 100^\circ\text{C}, I_T = 2000\text{A},$ $t_p > 2\text{msec}, di_T/dt = 5\text{A}/\mu\text{sec}$ $dv/dt = 1000\text{V}/\mu\text{sec}$ Linear to 2000V, $V_R = 100\text{V}$		400		$\mu\text{sec}$
Minimum Critical $dv/dt$ - Exponential to $V_{DRM}$	$dv/dt$	$T_j = 125^\circ\text{C}$	1000			V/ $\mu\text{sec}$
Gate Trigger Current	$I_{GT}$	$T_j = 25^\circ\text{C}, V_D = 12\text{V}_{DC}$			300	mA
Gate Trigger Voltage	$V_{GT}$	$T_j = 25^\circ\text{C}, V_D = 12\text{V}_{DC}$			4.5	Volts
Non-Triggering Gate Voltage	$V_{GDM}$	$T_j = 125^\circ\text{C}, V_D = 2000\text{V}$			0.8	Volts
Peak Forward Gate Current	$I_{GTM}$				20	A
Peak Reverse Gate Voltage	$V_{GRM}$				20	Volts

**Thermal Characteristics**

Maximum Thermal Resistance, Double Sided Cooling

Junction-to-Case	$R_{\theta(j-c)}$		0.012	$^\circ\text{C/W}$
Case-to-Sink	$R_{\theta(c-s)}$		0.002	$^\circ\text{C/W}$

Powerex, Inc., 200 Hillis Street, Youngwood, Pennsylvania 15697-1800 (412) 925-7272  
 Powerex, Europe, S.A. 428 Avenue G. Durand, BP107, 72003 Le Mans, France (43) 41.14.14

**C784**  
**Phase Control SCR**  
 1650 Amperes Average, 4500 Volts

**Maximum On-State Forward Voltage Drop**  
 ( $T_J = 125^\circ\text{C}$ )

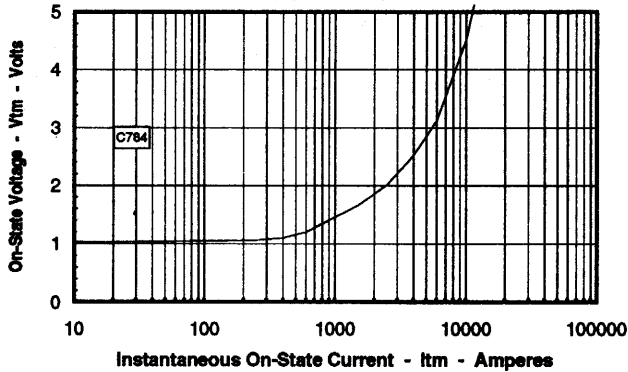

**Maximum Transient Thermal Impedance**  
 (Junction to Case)

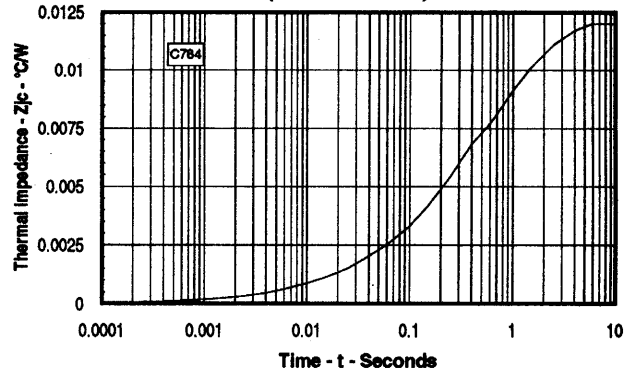

**Maximum On-State Power Dissipation**  
 (Sinusoidal Waveform)

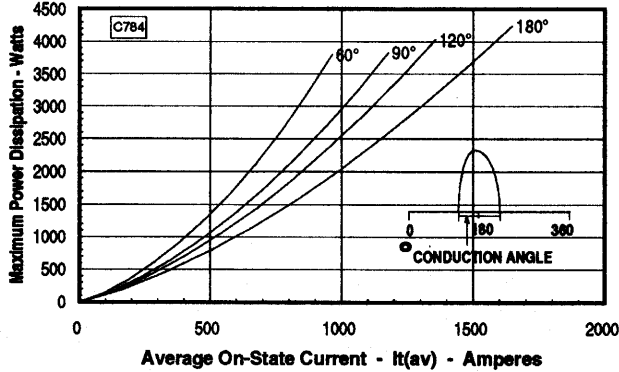

**Maximum Allowable Case Temperature**  
 (Sinusoidal Waveform)

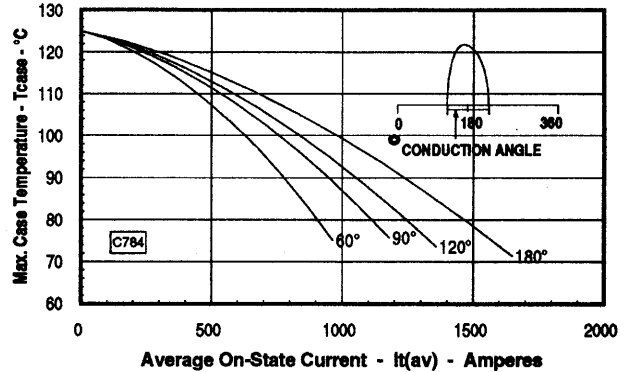

**Maximum On-State Power Dissipation**  
 (Rectangular Waveform)

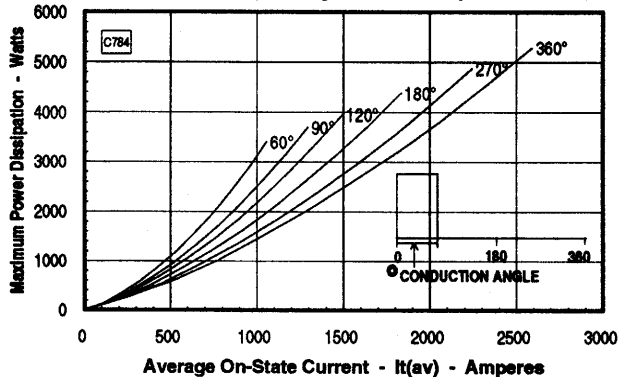

**Maximum Allowable Case Temperature**  
 (Rectangular Waveform)

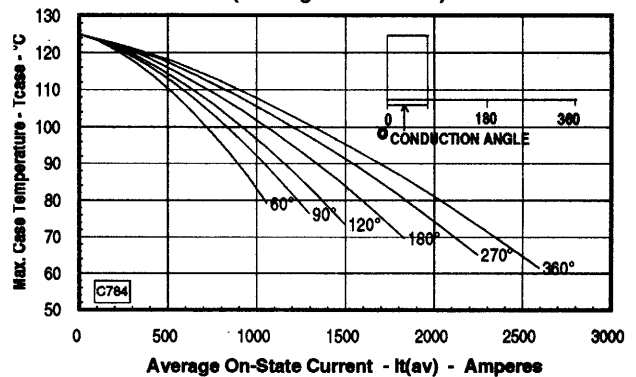

Note: Spreading losses included. Curves are for an inductive load.