

Powerex, Inc., 200 Hillis Street, Youngwood, Pennsylvania 15697-1800 (412) 925-7272
 Powerex, Europe, S.A. 428 Avenue G. Durand, BP107, 72003 Le Mans, France (43) 41.14.14

Phase Control SCR
 1800 Amperes Average
 3700 Volts

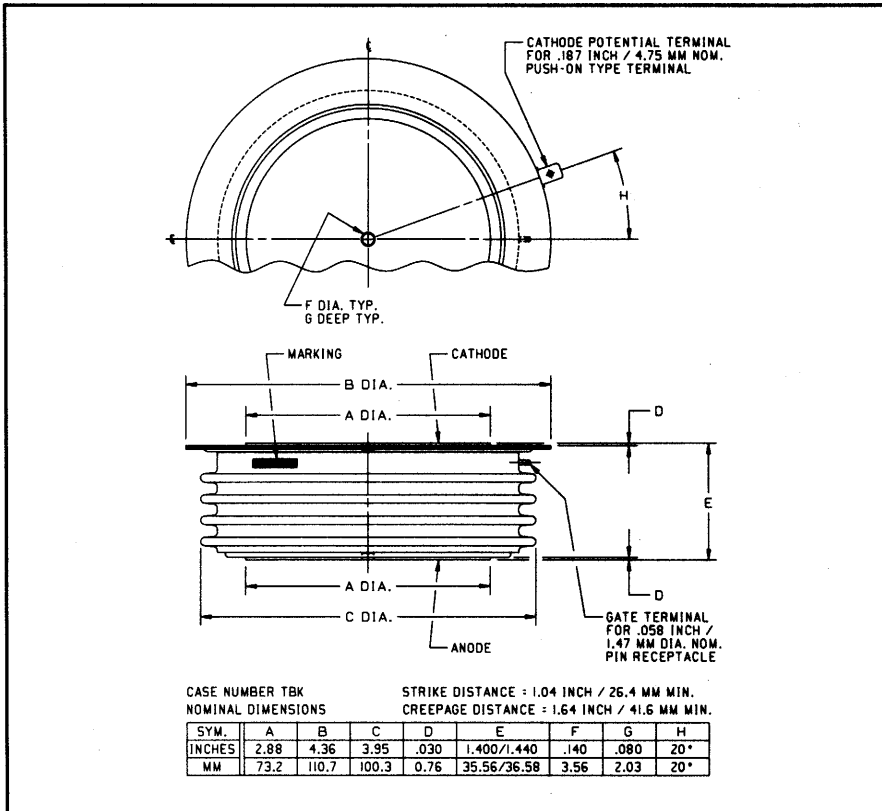

C783 (Outline Drawing)

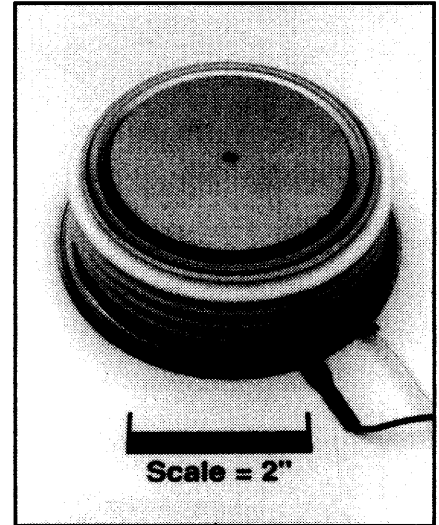

C783 Phase Control SCR
 1800 Amperes Average, 3700 Volts

Ordering Information:

Select the complete six digit part number you desire from the table, i.e. C783CS is a 3700 Volt, 1800 Ampere Phase Control SCR.

Type	Voltage		Current
	V _{DRM} V _{RRM}	Code	I _{T(av)}
C783	3000	CP	1800
	3200	CB	
	3400	CD	
	3600	CM	
	3700	CS	

Description:

Powerex Silicon Controlled Rectifiers (SCR) are designed for phase control applications. These are all-diffused, Press-Pak, hermetic Pow-R-Disc devices employing the field proven amplifying gate.

Features:

- Low On-State Voltage
- High di/dt Capability
- High dv/dt Capability
- Hermetic Packaging
- Excellent Surge and I²t Ratings

Applications:

- Power Supplies
- Motor Control
- VAR Generators



Powerex, Inc., 200 Hillis Street, Youngwood, Pennsylvania 15697-1800 (412) 925-7272
Powerex, Europe, S.A. 428 Avenue G. Durand, BP107, 72003 Le Mans, France (43) 41.14.14

C783

Phase Control SCR

1800 Amperes Average, 3700 Volts

Absolute Maximum Ratings

Characteristics	Symbol	C783	Units
Non-repetitive Transient Peak Reverse Voltage	V_{RSM}	$V_{RRM} + 100V$	Volts
RMS On-state Current, $T_C = 70^\circ C$	$I_{T(rms)}$	2826	Amperes
Average Current 180° Sine Wave, $T_C = 70^\circ C$	$I_{T(av)}$	1800	Amperes
RMS On-state Current, $T_C = 55^\circ C$	$I_{T(rms)}$	3300	Amperes
Average Current 180° Sine Wave, $T_C = 55^\circ C$	$I_{T(av)}$	2100	Amperes
Peak One Cycle Surge On-state Current (Non-repetitive) 60Hz	I_{tsm}	29000	Amperes
Peak One Cycle Surge On-state Current (Non-repetitive) 50Hz	I_{tsm}	27000	Amperes
Critical Rate-of-rise of On-state Current (Non-repetitive)	di/dt	600	A/ μ sec
Critical Rate-of-rise of On-state Current (Repetitive)	di/dt	100	A/ μ sec
I^2t (for Fusing) for One Cycle, 60Hz	I^2t	3.5×10^6	A ² sec
Peak Gate Power Dissipation	P_{GM}	250	Watts
Average Gate Power Dissipation	$P_{G(av)}$	35	Watts
Operating Temperature	T_j	-40 to +125°C	°C
Storage Temperature	T_{stg}	-40 to +150°C	°C
Approximate Weight		3.5	lb.
		1.60	kg
Mounting Force		9000 to 10000	lb.
		40 to 44.5	kN



Powerex, Inc., 200 Hillis Street, Youngwood, Pennsylvania 15697-1800 (412) 925-7272
 Powerex, Europe, S.A. 428 Avenue G. Durand, BP107, 72003 Le Mans, France (43) 41.14.14

C783
 Phase Control SCR
 1800 Amperes Average, 3700 Volts

Electrical Characteristics, $T_j = 25^\circ\text{C}$ Unless Otherwise Specified

Characteristics	Symbol	Test Conditions	Min.	Typ.	Max.	Units
Repetitive Peak Reverse Leakage Current	I_{RRM}	$T_j = 125^\circ\text{C}$, $V_R = V_{RRM}$			150	mA
Repetitive Peak Forward Leakage Current	I_{DRM}	$T_j = 125^\circ\text{C}$, $V_D = V_{DRM}$			150	mA
Peak On-state Voltage	V_{TM}	$T_j = 125^\circ\text{C}$, $I_{TM} = 2000\text{A Peak}$ Duty Cycle < 0.1%			1.71	Volts
Threshold Voltage, Low-level	$V_{(TO)1}$	$T_j = 125^\circ\text{C}$, $I = 15\%$, $I_{T(av)}$ to $\pi I_{T(av)}$			1.1135	Volts
Slope Resistance, Low-level	r_{T1}				0.2778	m Ω
Threshold Voltage, High-level	$V_{(TO)2}$	$T_j = 125^\circ\text{C}$, $I = \pi I_{T(av)}$ to I_{TSM}			1.270	Volts
Slope Resistance, High-level	r_{T2}				0.2463	m Ω
V_{TM} Coefficients, Low-level		$T_j = 125^\circ\text{C}$, $I = 15\%$ $I_{T(av)}$ to $\pi I_{T(av)}$				$A_1 = 0.53024$ $B_1 = 0.1030$ $C_1 = 2.481\text{E-}04$ $D_1 = -0.002243$
V_{TM} Coefficients, High-level		$T_j = 125^\circ\text{C}$, $I = \pi I_{T(av)}$ to I_{TSM}				$A_2 = 0.4700$ $B_2 = 0.11186$ $C_2 = 2.486\text{E-}04$ $D_2 = -0.002498$
Typical Delay Time	t_d	$T_j = 125^\circ\text{C}$, $V_D = 1800\text{V}$		3		μsec
Typical Turn-off Time	t_q	$T_j = 125^\circ\text{C}$, $I_{TM} = 500\text{A}$, $di_R/dt = 25\text{A}/\mu\text{sec}$ Reapplied $dv/dt = 20\text{V}/\mu\text{sec}$ Linear to $0.8V_{DRM}$, $V_R \geq 50\text{V}$		200		μsec
Minimum Critical dv/dt - Exponential to V_{DRM}	dv/dt	$T_j = 125^\circ\text{C}$, $V_D = 0.8 V_{DRM}$	500			V/ μsec
Gate Trigger Current	I_{GT}	$T_j = 25^\circ\text{C}$, $V_D = 12V_{DC}$			250	mA
Gate Trigger Voltage	V_{GT}	$T_j = 25^\circ\text{C}$, $V_D = 12V_{DC}$			4.5	Volts
Non-Triggering Gate Voltage	V_{GDM}	$T_j = 125^\circ\text{C}$, $V_D = 1800\text{V}$			0.8	Volts
Peak Forward Gate Current	I_{GTM}				20	A
Peak Reverse Gate Voltage	V_{GRM}				20	Volts

Thermal Characteristics

Maximum Thermal Resistance, Double Sided Cooling

Junction-to-Case	$R_{\theta(j-c)}$	0.012	$^\circ\text{C}/\text{W}$
Case-to-Sink	$R_{\theta(c-s)}$	0.002	$^\circ\text{C}/\text{W}$

Powerex, Inc., 200 Hillis Street, Youngwood, Pennsylvania 15697-1800 (412) 925-7272
 Powerex, Europe, S.A. 428 Avenue G. Durand, BP107, 72003 Le Mans, France (43) 41.14.14

C783
Phase Control SCR
 1800 Amperes Average, 3700 Volts

Maximum On-State Forward Voltage Drop
 ($T_J = 125^\circ\text{C}$)

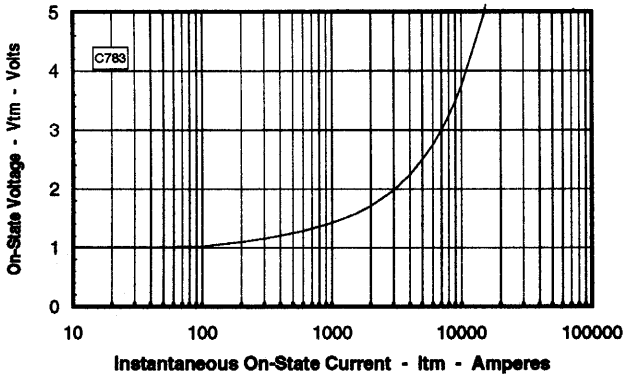

Maximum Transient Thermal Impedance
 (Junction to Case)

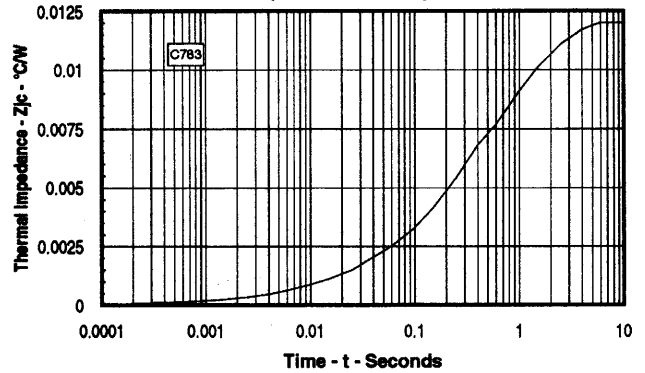

Maximum On-State Power Dissipation
 (Sinusoidal Waveform)

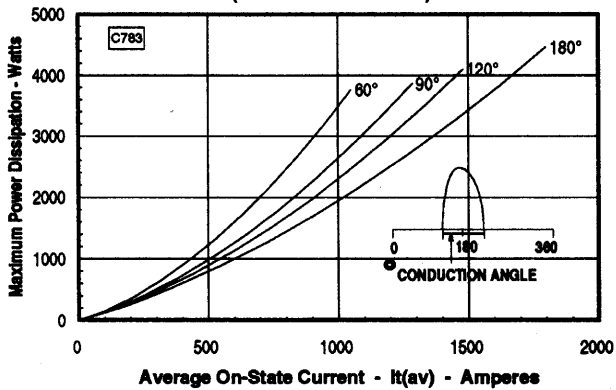

Maximum Allowable Case Temperature
 (Sinusoidal Waveform)

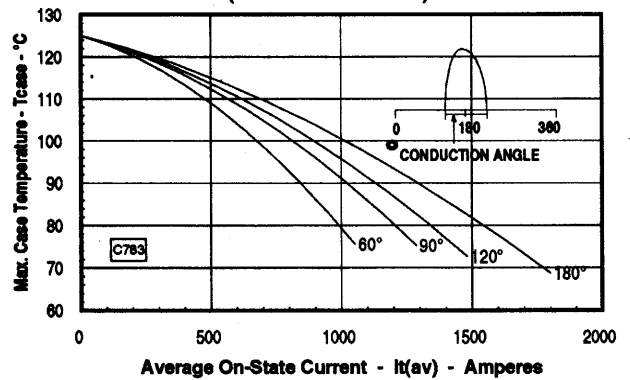

Maximum On-State Power Dissipation
 (Rectangular Waveform)

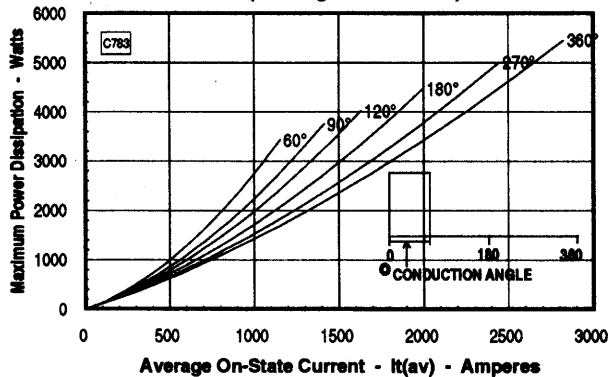

Maximum Allowable Case Temperature
 (Rectangular Waveform)

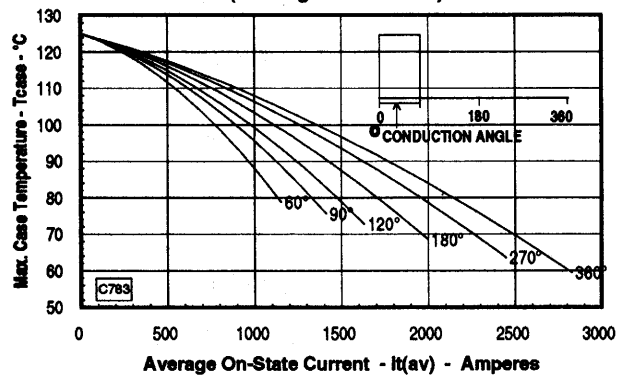

Note: Spreading losses included. Curves are for an inductive load.