

Powerex, Inc., 200 Hillis Street, Youngwood, Pennsylvania 15697-1800 (412) 925-7272
 Powerex, Europe, S.A. 428 Avenue G. Durand, BP107, 72003 Le Mans, France (43) 41.14.14

Phase Control SCR 2500 Amperes Average 2100 Volts

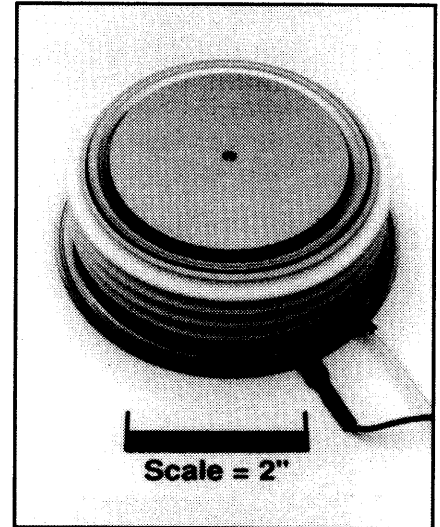
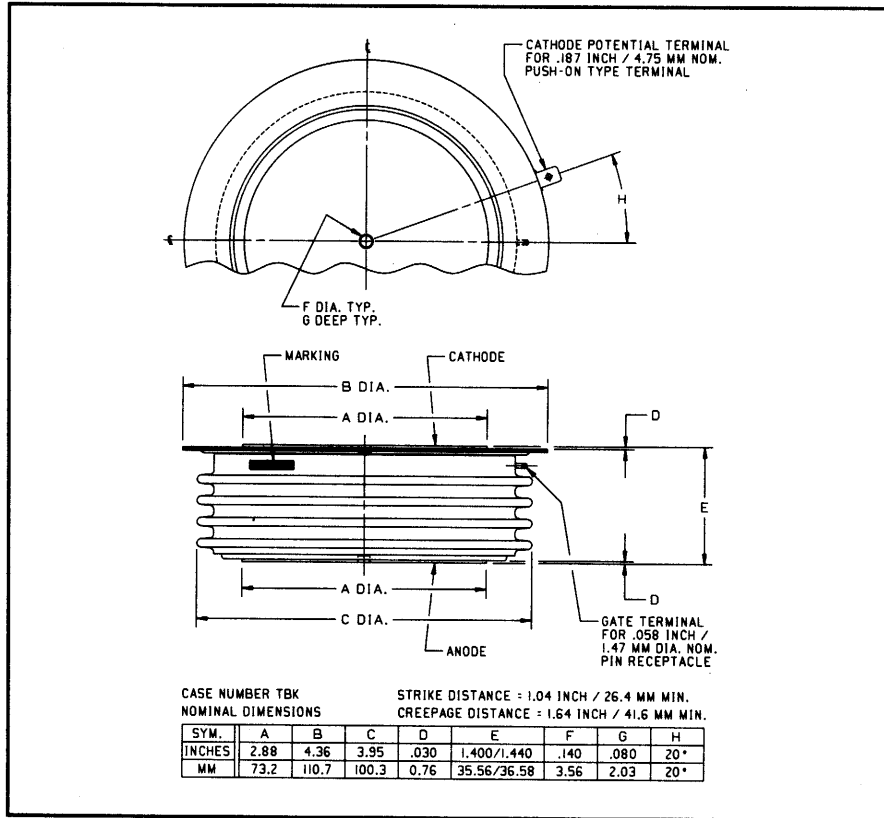

C781 Phase Control SCR
 2500 Amperes Average, 2100 Volts

C781 (Outline Drawing)

Description:

Powerex Silicon Controlled Rectifiers (SCR) are designed for phase control applications. These are all-diffused, Press-Pak, hermetic Pow-R-Disc devices employing the field proven amplifying gate.

Features:

- Low On-State Voltage
- High di/dt Capability
- High dv/dt Capability
- Hermetic Packaging
- Excellent Surge and I^2t Ratings

Applications:

- Power Supplies
- Motor Control

Ordering Information:

Select the complete five or six digit part number you desire from the table, i.e. C781LA is a 2100 Volt, 2500 Ampere Phase Control SCR.

| Type | Voltage | | Current |
|------|------------------------|------|-------------|
| | V_{DRM} V_{RRM} | Code | $I_{T(av)}$ |
| C781 | 1200 | PB | 2500 |
| | 1400 | PD | |
| | 1600 | PM | |
| | 1800 | PN | |
| | 2000 | L | |
| | 2100 | LA | |

C781
Phase Control SCR
 2500 Amperes Average, 2100 Volts

Absolute Maximum Ratings

| Characteristics | Symbol | C781 | Units |
|---|-------------|-------------------|--------------------|
| Non-repetitive Transient Peak Reverse Voltage | V_{RSM} | $V_{RRM} + 100V$ | Volts |
| RMS On-state Current, $T_C = 72^\circ C$ | $I_T(rms)$ | 3925 | Amperes |
| Average Current 180° Sine Wave, $T_C = 72^\circ C$ | $I_T(av)$ | 2500 | Amperes |
| RMS On-state Current, $T_C = 55^\circ C$ | $I_T(rms)$ | 4820 | Amperes |
| Average Current 180° Sine Wave, $T_C = 55^\circ C$ | $I_T(av)$ | 3070 | Amperes |
| Peak One Cycle Surge On-state Current (Non-repetitive) 60Hz | I_{tsm} | 45000 | Amperes |
| Peak One Cycle Surge On-state Current (Non-repetitive) 50Hz | I_{tsm} | 41500 | Amperes |
| Critical Rate-of-rise of On-state Current (Non-repetitive) | di/dt | 600 | A/ μ sec |
| Critical Rate-of-rise of On-state Current (Repetitive) | di/dt | 100 | A/ μ sec |
| I^2t (for Fusing) for One Cycle, 60Hz | I^2t | 8.5×10^6 | A ² sec |
| Peak Gate Power Dissipation | P_{GM} | 250 | Watts |
| Average Gate Power Dissipation | $P_{G(av)}$ | 35 | Watts |
| Operating Temperature | T_j | -40 to +125°C | °C |
| Storage Temperature | T_{stg} | -40 to +150°C | °C |
| Approximate Weight | | 3.5 | lb. |
| | | 1.60 | kg |
| Mounting Force | | 9000 to 10000 | lb. |
| | | 40 to 44.5 | kN |

C781
 Phase Control SCR
 2500 Amperes Average, 2100 Volts

Electrical Characteristics, $T_j = 25^\circ\text{C}$ Unless Otherwise Specified

| Characteristics | Symbol | Test Conditions | Min. | Typ. | Max. | Units |
|---|-------------|---|------|------|---|--------------------|
| Repetitive Peak Reverse Leakage Current | I_{RRM} | $T_j = 125^\circ\text{C}, V_R = V_{RRM}$ | | | 150 | mA |
| Repetitive Peak Forward Leakage Current | I_{DRM} | $T_j = 125^\circ\text{C}, V_D = V_{DRM}$ | | | 150 | mA |
| Peak On-state Voltage | V_{TM} | $T_j = 125^\circ\text{C}, I_T = 2000\text{A Peak}$ Duty Cycle < 0.1% | | | 1.20 | Volts |
| Threshold Voltage, Low-level | $V_{(TO)1}$ | $T_j = 125^\circ\text{C}, I = 15\%, I_{T(av)}$ to $\pi I_{T(av)}$ | | | 0.94963 | Volts |
| Slope Resistance, Low-level | r_{T1} | | | | 0.1234 | m Ω |
| Threshold Voltage, High-level | $V_{(TO)2}$ | $T_j = 125^\circ\text{C}, I = \pi I_{T(av)}$ to I_{TSM} | | | 1.1007 | Volts |
| Slope Resistance, High-level | r_{T2} | | | | 0.1149 | m Ω |
| V_{TM} Coefficients, Low-level | | $T_j = 125^\circ\text{C}, I = 15\% I_{T(av)}$ to $\pi I_{T(av)}$ | | | $A_1 = -0.007132$ $B_1 = 0.18721$ $C_1 = 1.589\text{E-}04$ $D_1 = -0.011393$ | |
| V_{TM} Coefficients, High-level | | $T_j = 125^\circ\text{C}, I = \pi I_{T(av)}$ to I_{TSM} | | | $A_2 = 30.510$ $B_2 = -4.6029$ $C_2 = -2.083\text{E-}04$ $D_2 = 0.1610$ | |
| Typical Delay Time | t_d | $T_j = 125^\circ\text{C}, V_D = 1500\text{V}$ | | 3 | | μsec |
| Typical Turn-off Time | t_q | $T_j = 125^\circ\text{C}, I_T = 2000\text{A},$ $t_p > 3\text{msec}, di_T/dt = 5\text{A}/\mu\text{sec},$ V Reapplied = 1000V, $dv/dt = 1000\text{V}/\mu\text{sec}, V_R = 100\text{V}$ | | 250 | | μsec |
| Minimum Critical dv/dt - Exponential to V_{DRM} | dv/dt | $T_j = 125^\circ\text{C}, V_D = 0.8 V_{DRM}$ | 500 | | | V/ μsec |
| Gate Trigger Current | I_{GT} | $T_j = 25^\circ\text{C}, V_D = 12\text{V}_{DC}$ | | | 250 | mA |
| Gate Trigger Voltage | V_{GT} | $T_j = 25^\circ\text{C}, V_D = 12\text{V}_{DC}$ | | | 4.2 | Volts |
| Non-Triggering Gate Voltage | V_{GDM} | $T_j = 125^\circ\text{C}, V_D = 1000\text{V}$ | | | 0.5 | Volts |
| Peak Forward Gate Current | I_{GTM} | | | | 20 | A |
| Peak Reverse Gate Voltage | V_{GRM} | | | | 20 | Volts |

Thermal Characteristics

Maximum Thermal Resistance, Double Sided Cooling

| | | | | | |
|------------------|-------------------|--|--|-------|---------------------------|
| Junction-to-Case | $R_{\theta(j-c)}$ | | | 0.012 | $^\circ\text{C}/\text{W}$ |
| Case-to-Sink | $R_{\theta(c-s)}$ | | | 0.002 | $^\circ\text{C}/\text{W}$ |

C781
Phase Control SCR
 1500 Amperes Average, 2400 Volts

Maximum On-State Forward Voltage Drop
 ($T_J = 125^\circ\text{C}$)

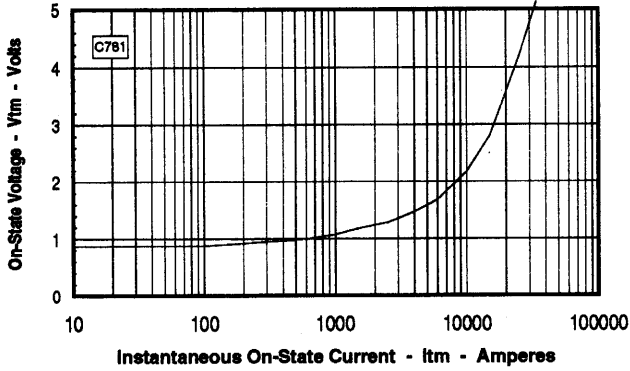

Maximum Transient Thermal Impedance
 (Junction to Case)

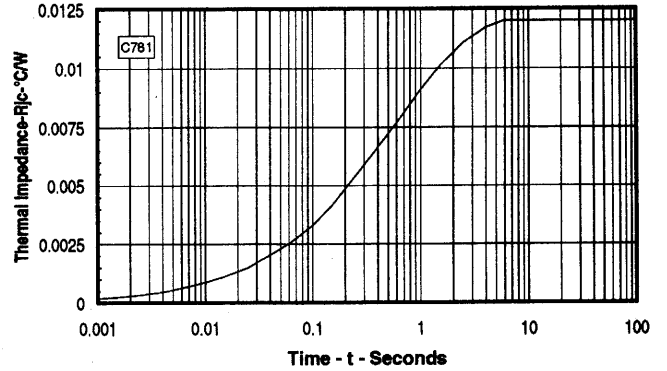

Maximum On-State Power Dissipation
 (Sinusoidal Waveform)

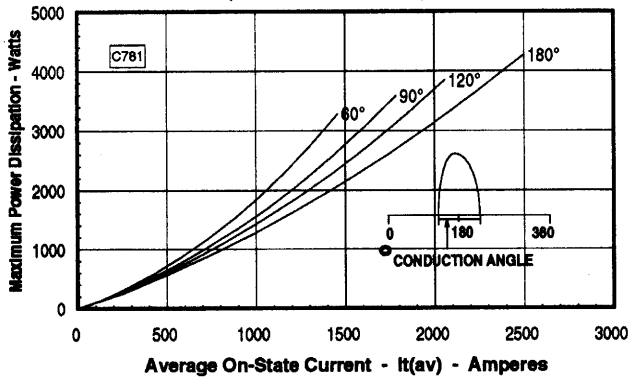

Maximum Allowable Case Temperature
 (Sinusoidal Waveform)

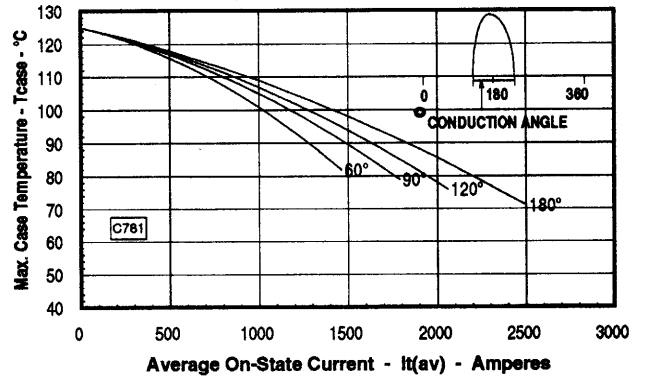

Maximum On-State Power Dissipation
 (Rectangular Waveform)

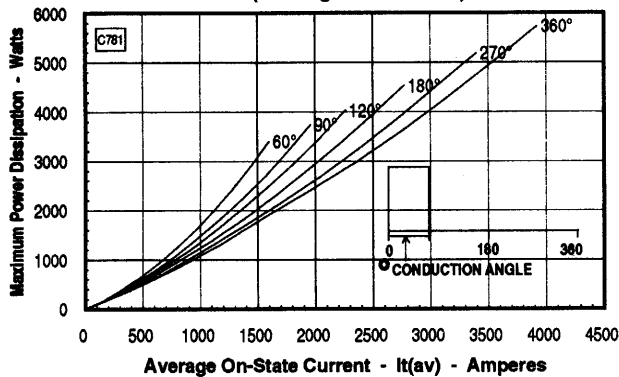

Maximum Allowable Case Temperature
 (Rectangular Waveform)

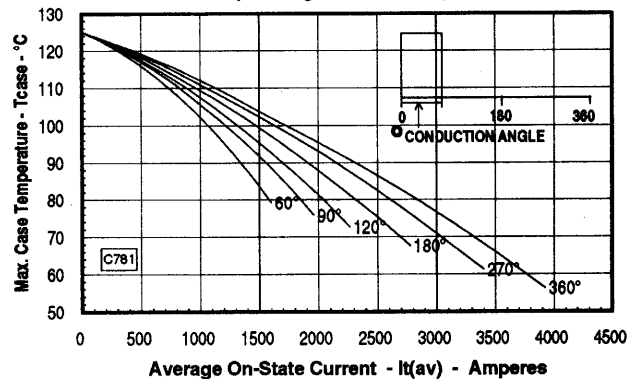

Note: Spreading losses included. Curves are for an inductive load.