

Powerex, Inc., Hillis Street, Youngwood, Pennsylvania 15697 (412)925-7272
 Powerex Europe, S.A., 428 Avenue G. Durand, BP107, 72003 Le Mans, France(43) 72.75.15

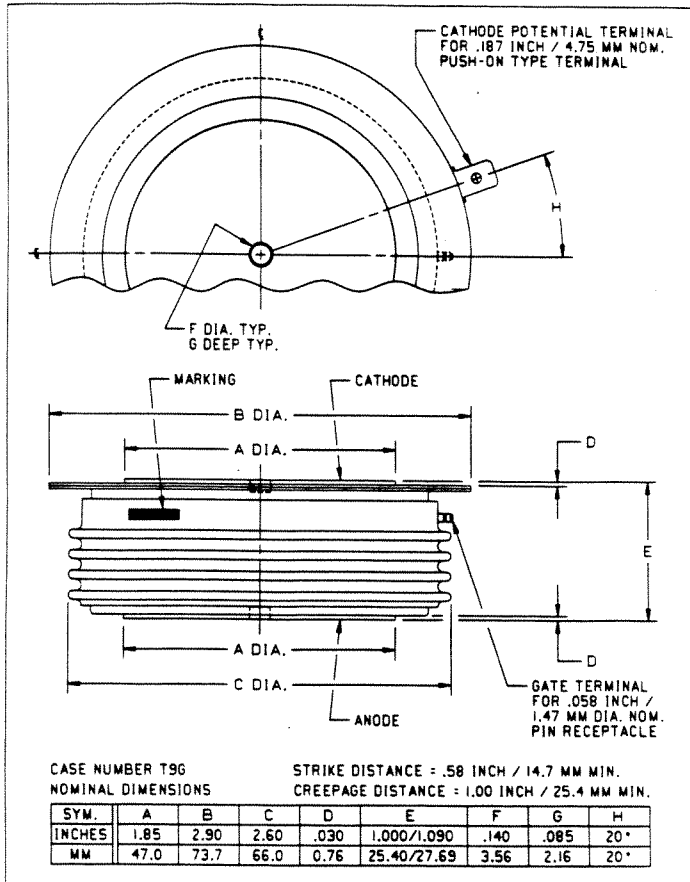

Fast Switching Thyristor

1000 Amperes/Up to 2000 Volts

Description:

Powerex Silicon Controlled Rectifiers (SCR) are designed for high current, fast switching applications. The involute, interdigitated gate pattern optimizes the turn-on area for high di/dt capability.

Features:

- Low Switching Losses at High Frequency
- Interdigitated, di/namic Gate Structure
- Up to 2000 Volt Off-State and Reverse Blocking Capability
- Hermetic Packaging

Applications:

- Induction Heating
- Transportation
- Inverters

Ordering Information

Select the complete five or six digit device part number from the table below.

Type	Voltage Code	V _{DRM} V _{RRM}
C712	L	2000 V
	PN	1800 V
	PM	1600 V
	PD	1400 V
	PB	1200 V



Powerex, Inc., Hillis Street, Youngwood, Pennsylvania 15697 (412)925-7272
Powerex Europe, S.A., 428 Avenue G. Durand, BP107, 72003 Le Mans, France(43) 72.75.15

C712

Fast Switching SCR

1000 Amperes Avg / Up to 2000 Volts

Absolute Maximum Ratings

Characteristics	Symbol		Units
RMS On-State Current	$I_{T(RMS)}$	1570	A
Average Current	$I_{T(AV)}$	1000	A
Peak One Cycle Surge On-State Current (Non-Repetitive) 60Hz	I_{TSM}	20,000	A
Peak One Cycle Surge On-State Current (Non-Repetitive) 50Hz	I_{TSM}	18,500	A
Critical Rate-of-Rise of On-State Current (Non-Repetitive)	di/dt	800	A/ μ s
Critical Rate-of-Rise of On-State Current (Repetitive)	di/dt	200	A/ μ s
I^2t for Fusing for One Cycle	I^2t	1,660,000	A ² s
Peak Gate Power Dissipation	P_{GM}	100	W
Average Gate Power Dissipation	$P_{G(av)}$	5	W
Operating Temperature	T_{STG}	-40 to 125°C	°C
Storage Temperature	T_J	-40 to 125°C	°C
Mounting Force		5000 to 6000 22.2 - 26.6	lb. kN



Powerex, Inc., Hillis Street, Youngwood, Pennsylvania 15697 (412)925-7272
 Powerex Europe, S.A., 428 Avenue G. Durand, BP107, 72003 Le Mans, France(43) 72.75.15

C712

Fast Switching SCR

1000 Amperes Avg / Up to 2000 Volts

Electrical Characteristics, $T_J = 25^\circ\text{C}$ unless otherwise specified

Characteristics	Symbol	Test Conditions	Min.	Typ.	Max.	Units
Repetitive Peak Reverse Leakage Current	I_{RRM}	$T_J = 125^\circ\text{C}, V_D = V_{RRM}$			90	mA
Repetitive Peak Forward Leakage Current	I_{DRM}	$T_J = 125^\circ\text{C}, V_D = V_{DRM}$			90	mA
Peak On-State Voltage	V_{TM}	$T_J = 125^\circ\text{C}, I_{TM} = 1000\text{A}$ Duty Cycle < 0.01%			1.45	V
Typical Delay Time	t_d	Switching from 140V, 20V, 10 Ohm gate, 0.5 μs rise time, $T_J = 25^\circ\text{C}$		1.5		μs
Maximum Turn-Off Time	t_q	$T_J = 125^\circ\text{C}, I_T = 1000\text{A}, V_R > 50\text{V}$ $dv/dt = 400\text{V}/\mu\text{s}$ linear to 80% V_{DRM}			55	μs
Minimum Critical dv/dt - Linear to VDRM	dv/dt	$T_J = 125^\circ\text{C}, V_{DRM} = 80\%$ rated Gate Open	500			V/ μs
Gate Trigger Current	I_{GT}	$T_J = 25^\circ\text{C}, V_D = 10\text{V}, R_L = 3$ Ohm		120		mA
Gate Trigger Voltage	V_{GT}	$T_J = 0$ to $125^\circ\text{C}, V_D = 10\text{V}$ $R_L = 3$ Ohm		3.0		V
Peak Reverse Gate Voltage	V_{GRM}				20	V

Thermal Characteristics

Characteristics	Symbol	Min.	Typ.	Max.	Units
Maximum Thermal Resistance, Double Sided Cooling					
Junction to Case	$R_{\theta JC}$.023	$^\circ\text{C}/\text{W}$
Case to Sink	$R_{\theta CS}$.0075	$^\circ\text{C}/\text{W}$

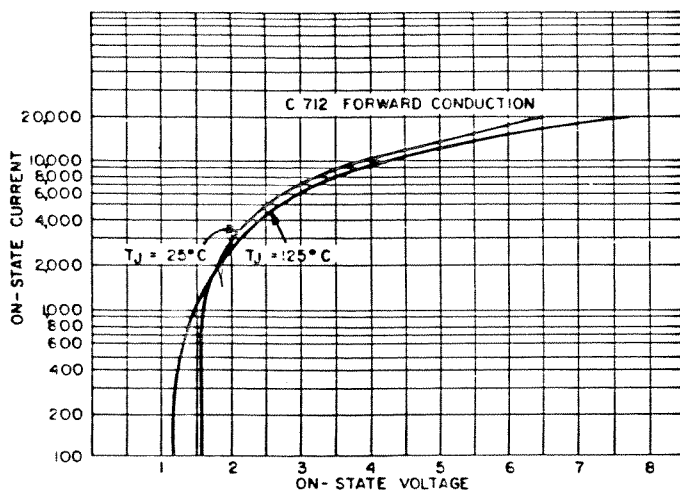

FORWARD CONDUCTION CHARACTERISTIC ON-STATE

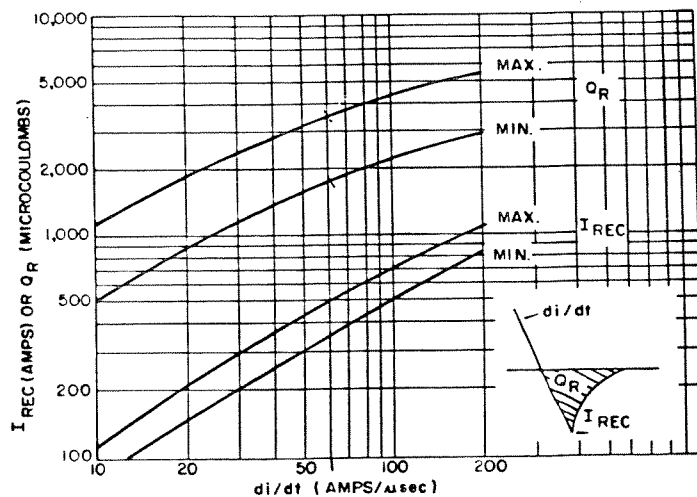

RECOVERED CHARGE (125°C)



Powerex, Inc., Hillis Street, Youngwood, Pennsylvania 15697 (412)925-7272
 Powerex Europe, S.A., 428 Avenue G. Durand, BP107, 72003 Le Mans, France(43) 72.75.15

C712
Fast Switching SCR
1000 Amperes Avg / Up to 2000 Volts

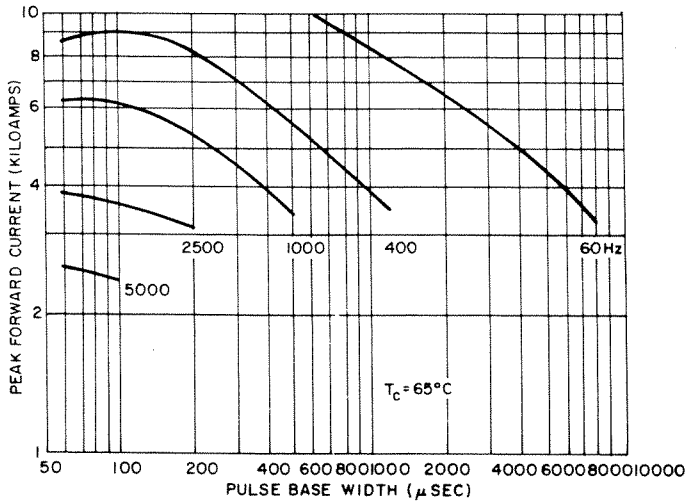

MAXIMUM ALLOWABLE PEAK ON-STATE CURRENT VS. PULSE WIDTH AT $T_c = 65^\circ\text{C}$

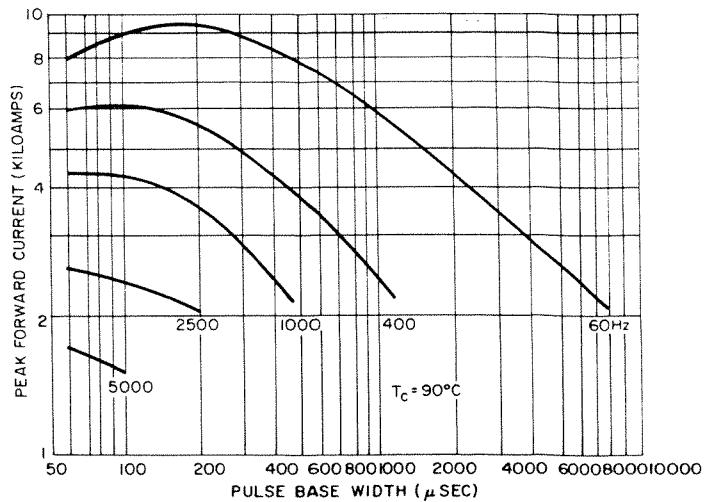

MAXIMUM ALLOWABLE PEAK ON-STATE CURRENT VS. PULSE WIDTH AT $T_c = 90^\circ\text{C}$

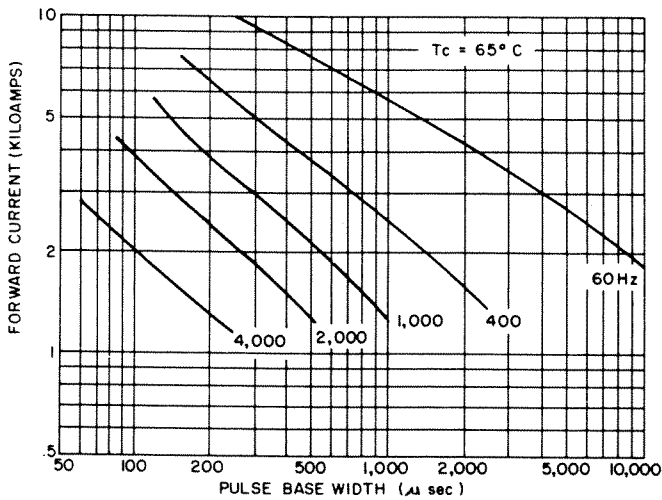

MAXIMUM ALLOWABLE PEAK ON-STATE CURRENT FOR TRAPEZOIDAL CURRENT WAVEFORMS FOR $T_c = 65^\circ\text{C}$

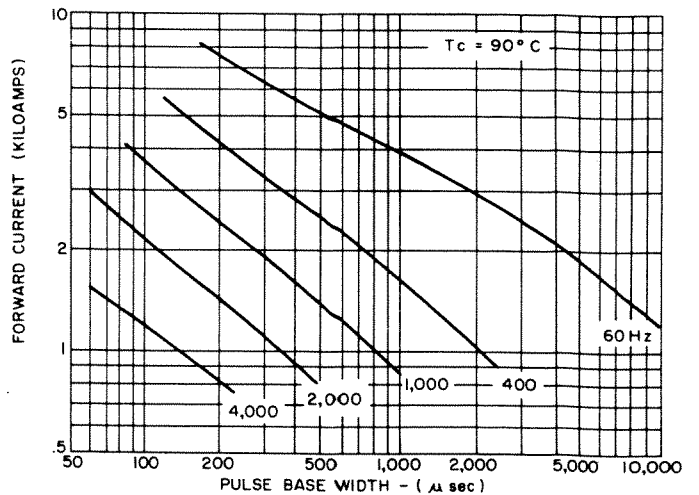

MAXIMUM ALLOWABLE PEAK ON-STATE CURRENT FOR TRAPEZOIDAL CURRENT WAVEFORMS FOR $T_c = 90^\circ\text{C}$



Powerex, Inc., Hillis Street, Youngwood, Pennsylvania 15697 (412)925-7272
 Powerex Europe, S.A., 428 Avenue G. Durand, BP107, 72003 Le Mans, France(43) 72.75.15

C712
Fast Switching SCR
1000 Amperes Avg / Up to 2000 Volts

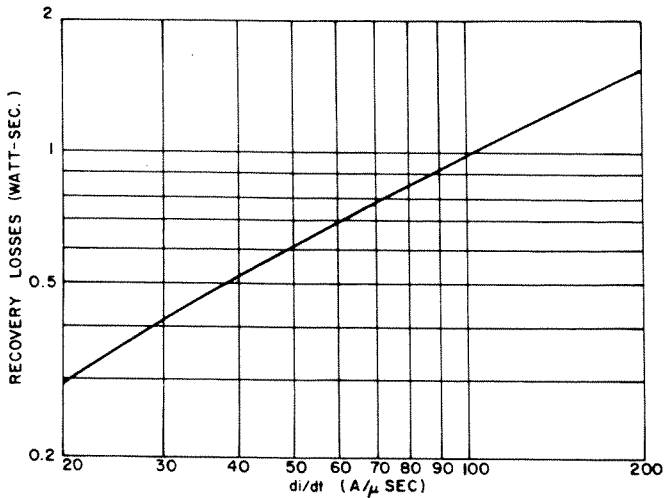

RECOVERY CURRENT SWITCHING LOSSES

NOTES:

If no bypass diode is used with this thyristor, the switching losses during recovery can be significant. The actual magnitude of these losses will vary widely depending on circuit conditions and snubber design. This curve represents typical recovery losses versus circuit di/dt. Since this curve is typical, it serves primarily to alert the equipment designer to the possible need for special design attention. The switching losses in a given circuit may be calculated with the following equation:

$$SLR = \int_0^{\infty} I(t) \cdot V(t) dt$$

Where SLR is the recovery switching losses; I (t) is the recovery current decay; V(t) is the recovery voltage; and t = 0 occurs at the peak of the recovery current. I (t) may be expressed as an exponential decay:

$$I(t) = I_{Re} - (t/T)$$

Where I_R is the peak recovery current and T = 2.5μsec. The junction temperature rise due to the recovery losses may be computed as follows:

$$\Delta T_j = F * \sigma_{\kappa} * R_{\theta JA} + \alpha_{\kappa} * 3.5$$

Where σ_{κ} is the recovery losses,

R_{θJA} is the DC junction to ambient thermal impedance, and F is the operating frequency.

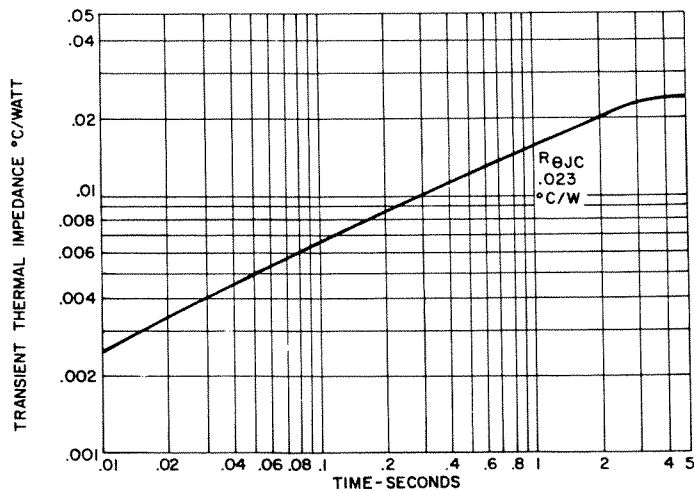
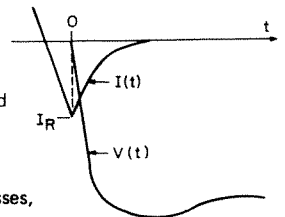

TRANSIENT THERMAL RESISTANCE – JUNCTION-TO-CASE

NOTES:

- Add .006°C/W to account for both case to dissipator interfaces when properly mounted; e.g., R_{θJS} = .029°C/W. See Mounting Instructions.
- DC Thermal Impedance is based on average full cycle junction temperature. Instantaneous junction temperature may be calculated using the following modifications:
 - end of conducting portion of cycle
 - 120° sq. wave add .0025°C/W along entire curve
 - 180° sq. wave add .0018°C/W along entire curve
 - 180° sine wave add .0010°C/W along entire curve
 - end of full cycle
 - any wave, subtract .001°C/W along entire curve

C712
Fast Switching SCR
1000 Amperes Avg / Up to 2000 Volts

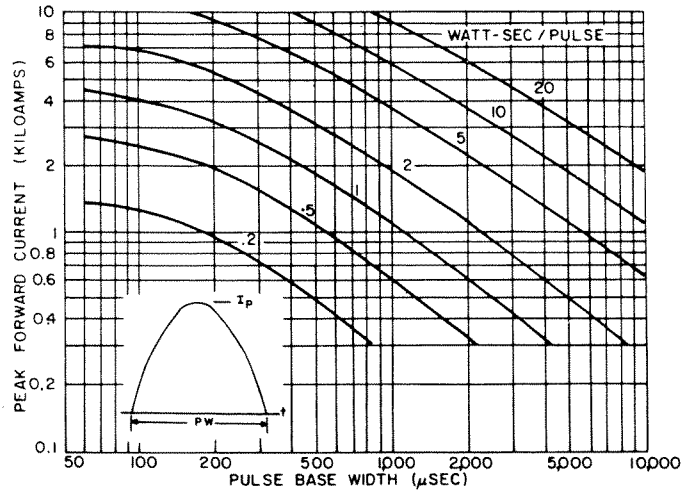

ENERGY PER PULSE FOR SINUSOIDAL PULSES

NOTES:

1. — Switching capability and losses with bypass diode.
2. Switching voltage from 15 Volts to $0.8 V_{DRM}$.
3. Snubber discharge < 50 Amps. RC time constant $< 10 \mu\text{sec}$.
4. High gate drive, 20V/10 Ohms, 0.5 μsec rise time.

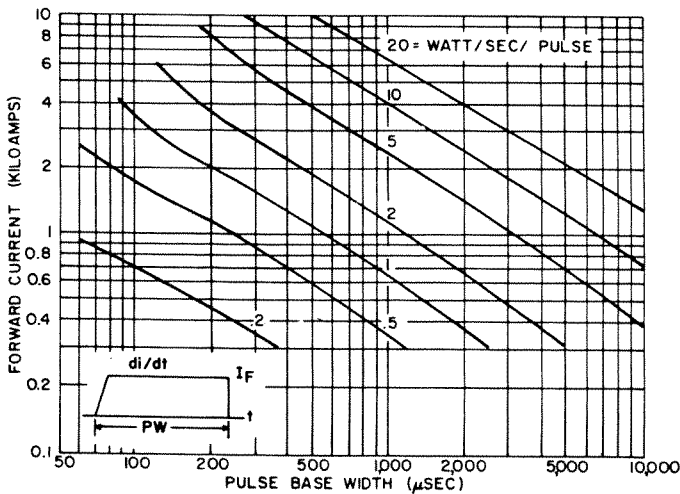

ENERGY PER PULSE FOR TRAPEZOIDAL CURRENT WAVEFORMS

NOTES:

1. Switching voltage from 15 Volts to $0.8 V_{DRM}$.
2. DI/DT during turn-on: $100A/\mu\text{sec}$.
3. Reverse voltage < 50 Volts. If no bypass diode is used, recovery switching losses must be added.
4. RC snubber time constant $< 10 \mu\text{sec}$.
5. High gate drive: 20V/10 Ohms, 0.5 μsec rise time.