

Powerex, Inc., 200 Hillis Street, Youngwood, Pennsylvania 15697-1800 (412) 925-7272  
 Powerex, Europe, S.A. 428 Avenue G. Durand, BP107, 72003 Le Mans, France (43) 41.14.14

**Phase Control SCR**  
 1500 Amperes Average  
 2400 Volts

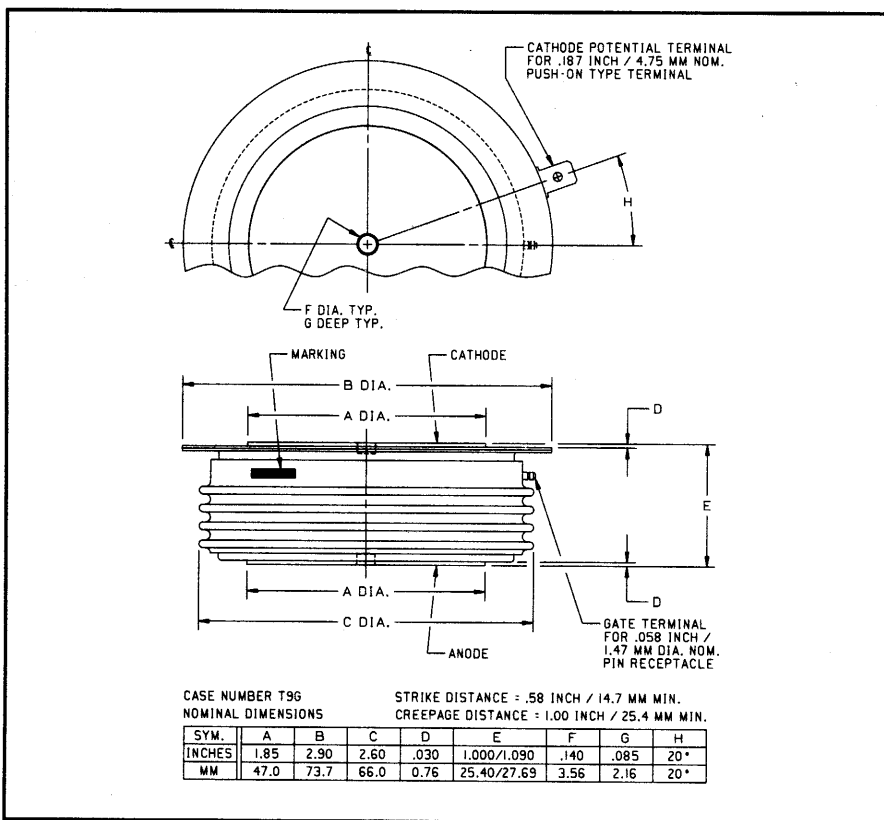

C451 (Outline Drawing)

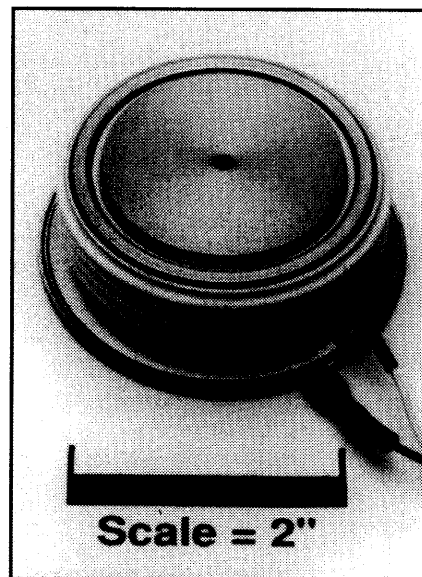

C451 Phase Control SCR  
 1500 Amperes Average, 2400 Volts

### Ordering Information:

Select the complete five or six digit part number you desire from the table, i.e. C451LD is a 2400 Volt, 1500 Ampere Phase Control SCR.

Type	Voltage		Current
	V <sub>DRM</sub> V <sub>RRM</sub>	Code	I <sub>T(av)</sub>
C451	1400	PD	1500
	1600	PM	
	1800	PN	
	2000	L	
	2200	LB	
	2400	LD	

### Description:

Powerex Silicon Controlled Rectifiers (SCR) are designed for phase control applications. These are all-diffused, Press-Pak, hermetic Pow-R-Disc devices employing the field proven amplifying gate.

### Features:

- Low On-State Voltage
- High di/dt Capability
- High dv/dt Capability
- Hermetic Packaging
- Excellent Surge and I<sup>2</sup>t Ratings

### Applications:

- Power Supplies
- Motor Control
- VAR Generators



Powerex, Inc., 200 Hillis Street, Youngwood, Pennsylvania 15697-1800 (412) 925-7272  
Powerex, Europe, S.A. 428 Avenue G. Durand, BP107, 72003 Le Mans, France (43) 41.14.14

C451  
Phase Control SCR  
1500 Amperes Average, 2400 Volts

### Absolute Maximum Ratings

Characteristics	Symbol	C451	Units
Non-repetitive Transient Peak Reverse Voltage	$V_{RSM}$	$V_{RRM} + 100V$	Volts
RMS On-state Current, $T_C = 64^\circ C$	$I_{T(rms)}$	2350	Amperes
Average Current 180° Sine Wave, $T_C = 64^\circ C$	$I_{T(av)}$	1500	Amperes
RMS On-state Current, $T_C = 55^\circ C$	$I_{T(rms)}$	2590	Amperes
Average Current 180° Sine Wave, $T_C = 55^\circ C$	$I_{T(av)}$	1650	Amperes
Peak One Cycle Surge On-state Current (Non-repetitive) 60Hz	$I_{tsm}$	23000	Amperes
Peak One Cycle Surge On-state Current (Non-repetitive) 50Hz	$I_{tsm}$	20800	Amperes
Critical Rate-of-rise of On-state Current (Non-repetitive)	$di/dt$	400	A/ $\mu$ sec
Critical Rate-of-rise of On-state Current (Repetitive)	$di/dt$	75	A/ $\mu$ sec
$I^2t$ (for Fusing) for One Cycle, 60Hz	$I^2t$	$2.2 \times 10^6$	A <sup>2</sup> sec
Peak Gate Power Dissipation	$P_{GM}$	200	Watts
Average Gate Power Dissipation	$P_{G(av)}$	5	Watts
Operating Temperature	$T_j$	-40 to +125°C	°C
Storage Temperature	$T_{stg}$	-40 to +150°C	°C
Approximate Weight		1	lb.
		454	g
Mounting Force		5500 to 6000	lb.
		2450 to 2670	kg.



Powerex, Inc., 200 Hillis Street, Youngwood, Pennsylvania 15697-1800 (412) 925-7272  
 Powerex, Europe, S.A. 428 Avenue G. Durand, BP107, 72003 Le Mans, France (43) 41.14.14

C451  
 Phase Control SCR  
 1500 Amperes Average, 2400 Volts

**Electrical Characteristics,  $T_j = 25^\circ\text{C}$  Unless Otherwise Specified**

Characteristics	Symbol	Test Conditions	Min.	Typ.	Max.	Units
Repetitive Peak Reverse Leakage Current	$I_{RRM}$	$T_j = 125^\circ\text{C}, V_R = V_{RRM}$			45	mA
Repetitive Peak Forward Leakage Current	$I_{DRM}$	$T_j = 125^\circ\text{C}, V_D = V_{DRM}$			45	mA
Peak On-state Voltage	$V_{TM}$	$I_{TM} = 3000\text{A Peak}$ Duty Cycle < 0.1%			1.7	Volts
Threshold Voltage, Low-level	$V_{(TO)1}$	$T_j = 125^\circ\text{C}, I = 15\%, I_{T(av)}$ to $\pi I_{T(av)}$			0.87956	Volts
Slope Resistance, Low-level	$r_{T1}$				0.2271	m $\Omega$
Threshold Voltage, High-level	$V_{(TO)2}$	$T_j = 125^\circ\text{C}, I = \pi I_{T(av)}$ to $I_{TSM}$			0.59931	Volts
Slope Resistance, High-level	$r_{T2}$				0.2781	m $\Omega$
$V_{TM}$ Coefficients, Low-level		$T_j = 125^\circ\text{C}, I = 15\% I_{T(av)}$ to $\pi I_{T(av)}$				
					$A_1 = 0.83982$	
					$B_1 = 4.972\text{E-}04$	
					$C_1 = 2.032\text{E-}04$	
					$D_1 = 0.002154$	
$V_{TM}$ Coefficients, High-level		$T_j = 125^\circ\text{C}, I = \pi I_{T(av)}$ to $I_{TSM}$				
					$A_2 = 12.127$	
					$B_2 = -1.8090$	
					$C_2 = 1.429\text{E-}04$	
					$D_2 = 0.064436$	
Typical Delay Time	$t_d$	$I_T = 50\text{A}, \text{Gate} = 20\text{V}, 20\Omega,$ 0.1 $\mu\text{sec Rise}$		0.7		$\mu\text{sec}$
Typical Turn-off Time	$t_q$	$T_j = 125^\circ\text{C}, I_T = 2000\text{A},$ $di_R/dt = 25\text{A}/\mu\text{sec}$ Reapplied $dv/dt = 200\text{V}/\mu\text{sec}$ Linear to 80% $V_{DRM}, V_R = 50\text{V},$ Gate = 0V, $R_{GK} = 100\Omega$		150		$\mu\text{sec}$
Minimum Critical $dv/dt$ - Exponential to $V_{DRM}$	$dv/dt$	$T_j = 125^\circ\text{C}$	400			V/ $\mu\text{sec}$
Gate Trigger Current	$I_{GT}$	$T_j = 25^\circ\text{C},$ $V_D = 20V_{DC}, R_L = 3\Omega$			200	mA
Gate Trigger Voltage	$V_{GT}$	$T_j = -40^\circ\text{C}$ to $+125^\circ\text{C},$ $V_D = 20\text{V}, R_L = 3\Omega$			5.0	Volts
Non-Triggering Gate Voltage	$V_{GDM}$	$T_j = 125^\circ\text{C},$ $V_D = V_{DRM}, R_L = 1000\Omega$			0.15	Volts
Peak Forward Gate Current	$I_{GTM}$				10	A
Peak Reverse Gate Voltage	$V_{GRM}$				5	Volts

**Thermal Characteristics**

Maximum Thermal Resistance, Double Sided Cooling

Junction-to-Case	$R_{\theta(j-c)}$	0.025	$^\circ\text{C/W}$
Case-to-Sink	$R_{\theta(c-s)}$	0.0075	$^\circ\text{C/W}$

Powerex, Inc., 200 Hillis Street, Youngwood, Pennsylvania 15697-1800 (412) 925-7272  
 Powerex, Europe, S.A. 428 Avenue G. Durand, BP107, 72003 Le Mans, France (43) 41.14.14

**C451**  
**Phase Control SCR**  
 1500 Amperes Average, 2400 Volts

**Maximum On-State Forward Voltage Drop**  
 (  $T_J = 125^\circ\text{C}$  )

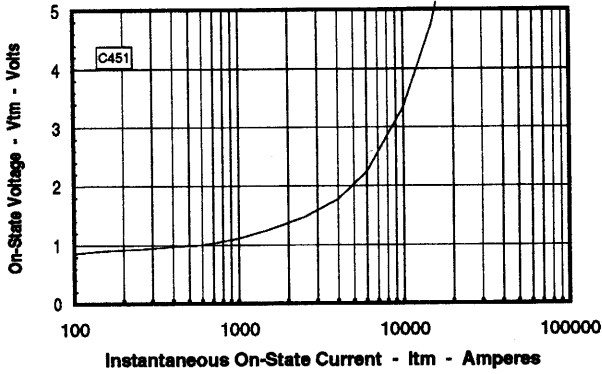

**Maximum Transient Thermal Impedance**  
 (Junction to Case)

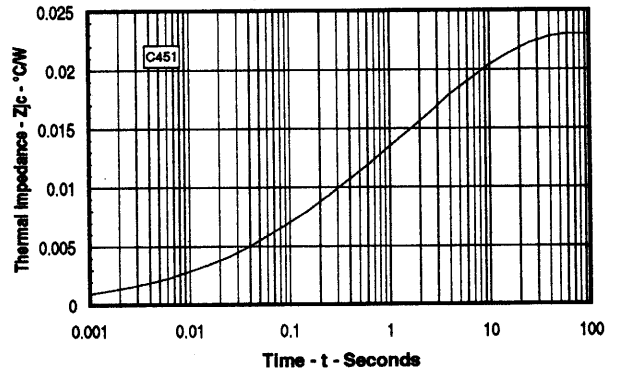

**Maximum On-State Power Dissipation**  
 (Sinusoidal Waveform)

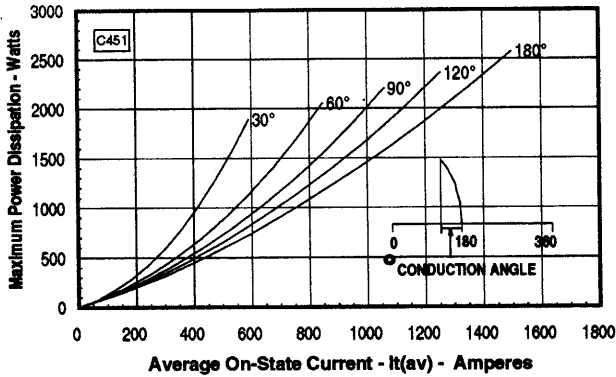

**Maximum Allowable Case Temperature**  
 (Sinusoidal Waveform)

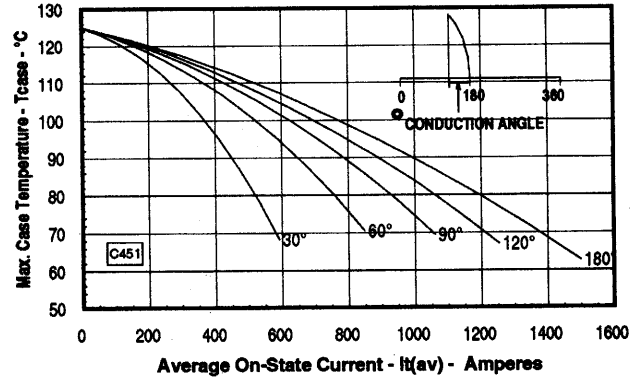

**Maximum On-State Power Dissipation**  
 (Rectangular Waveform)

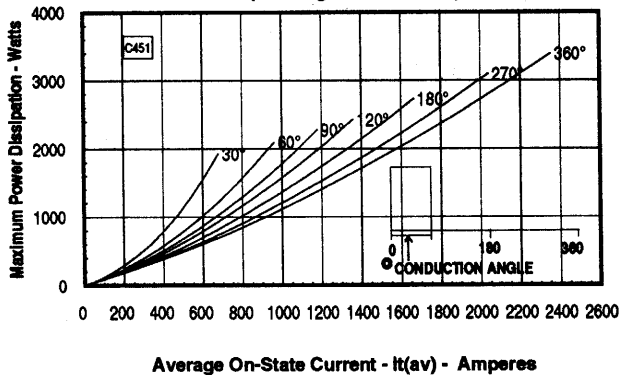

**Maximum Allowable Case Temperature**  
 (Rectangular Waveform)

